

CURATORIAL REPORT NUMBER 100

**OSTEOLOGICAL ATLAS OF THE BROWN  
BULLHEAD (*Ameiurus nebulosus*) FROM  
NOVA SCOTIA WATERS:  
A MORPHOLOGICAL AND BIOMETRIC  
STUDY**

Dr. Alfonso Rojo (Research Associate)



## CURATORIAL REPORTS

The Reports of the Nova Scotia Museum make technical information on museum collections, programs, procedures, and research accessible to interested readers.

This report contains the preliminary results of an on-going research program of the Museum. It may be cited in publications but its manuscript status should be noted.

---

© Crown Copyright 2013 Province of Nova Scotia  
Information in this report has been provided with the intent that it be readily available for research, personal and public non-commercial use and may be reproduced in part or in whole and by any means, without charge or further permission so long as credit is given to the Nova Scotia Museum.

ISBN# 978-1-55457-533-6

The correct citation for this publication is:

Rojo, A., 2013, Osteological Atlas of the Brown Bullhead (*Ameiurus nebulosus*) from Nova Scotia Waters: A Morphological and Biometric Study, Curatorial Report Number 100, Nova Scotia Museum, Halifax, 151 pages

*Ictalurus nebulosus* skeleton



Upper: Dorsal view. Lower: Ventral view. NSMNH#87927

# Acknowledgements

I would like to thank everyone that at one time or another offered me their support in any of the phases of this work. Special recognition is given to the NSM members, Mr. Andrew Hebda, Curator of Zoology, who provided the specimens and Museum facilities required for this study and Mr. John Gilhen, Curator Emeritus, who helped in recording biological information about the brown bullhead. Dr. A. Farrell, Henry Rojo, B.A. and Monica Rojo, B.A. patiently revised the long drafts. The SEM images of the otoliths and Weberian ossicles were taken by Mr. Xiang Yang, Research Instruments Technician of Saint Mary's University (Halifax, NS). The Royal Ontario Museum graciously loaned several specimens for reference.

## Abstract

This study presents the first complete description of the skeleton of the brown bullhead (*Ameiurus nebulosus*) with precise hand drawings of individual bones and of some osteological units. Two populations from Nova Scotia, one from St. Mary's River Watershed (Guysborough Co.) and another from Medway River Watershed (Queens Co.), distant some 275 km apart, were studied to find out whether there were significant osteological differences between them. These two small samples of 10 and 13 specimens, respectively, were compared. No significant variations in bone shape and bone relationships were noticed. Two exceptions are worth noting. Specimens # 1 and #2 from an unspecified locality in Hants Co. (Nova Scotia) have one, two, or three rows of teeth in the premaxillae and dentaries, while the remaining specimens have 5 to 6 rows. The lapillus' shape is elongated with a round outline while the lapillus, represented by McMurrich (1884) is tear-shaped.

The locations of the samples correspond to the quartzite barren regions designated 413b (St. Mary's River Watershed) and 412a (Medway River Watershed), respectively. The former, at 45° 13' N 62° 03' W is characterized by waters with a pH ranging from 5.0 -7.5 with an average of 6.5 and are in a dystrophic stage where eutrophication is common and consequently are biologically productive; the latter, at 44° 21' N 64° 5' W has fairly acidic surface water with a pH varying from 4.0 to 6.1 and low primary productivity (Davis and Browne, 1997).

Since the work is addressed to biologists and archaeologists, bones better suited to their work, were chosen for biometric study. The criteria for the selection of bones were: biological and archaeological significance, size, and degree of ossification. One or several dimensions were selected for the bones selected, according to these criteria. Measurements were obtained and related to the total length of the live fish. Total fish length (TFL) and standard fish length (SFL) show a high correlation coefficient ( $r = 0.996$ ). The correlations between the dimensions and total fish length are, in most cases, very high. Some decrease in the values of 'r' for width dimensions, when compared with those for lengths, is probably due to the lack of perfect bilateral symmetry. This fact was also noticed when measuring the bones.

# TABLE OF CONTENTS

|  |           |
|--|-----------|
| ACKNOWLEDGEMENTS .....                                     | 4         |
| ABSTRACT .....   | 5         |
| LIST OF FIGURES .....                                      | 8         |
| <b>I. INTRODUCTION .....</b>                               | <b>10</b> |
| I.1 Systematic position of <i>Ameiurus nebulosus</i> ..... | 10        |
| I.2 Objective .....  | 10        |
| I.3 History of bullhead's osteological studies .....       | 11        |
| I.4 Material and Methods .....                             | 12        |
| I.5 Bone nomenclature .....                                | 13        |
| I.6 Definition and Description of bones.....               | 14        |
| I.7 Synonymy of bone names .....                           | 14        |
| I.8 Osteometry .....                                       | 15        |
| I.9 Illustrations.....                                     | 15        |
| I.10 Biometric study .....                                 | 15        |
| <b>II. DESCRIPTION OF OSTEOLOGICAL UNITS .....</b>         | <b>16</b> |
| II.A NEUROCRANIUM.....                                     | 16        |
| II.A.1 ETHMOIDAL REGION .....                              | 19        |
| A.1a ETHMOID.....  | 19        |
| A.1b LATERAL ETHMOID.....                                  | 21        |
| II.A.2 ORBITOSPHEOID REGION.....                           | 22        |
| A.2a ORBITOSPHEOID .....                                   | 22        |
| A.2b PTEROSPHEOID.....                                     | 23        |
| A.2c SUPRASPHEOID.....                                     | 24        |
| II.A.3 OTIC REGION .....                                   | 24        |
| A.3a SPHENOTIC.....  | 24        |
| A.3b PROOTIC.....  | 25        |
| A.3c PTEROTIC.....   | 26        |
| II.A.4 OCCIPITAL REGION .....                              | 27        |
| A.4a SUPRAOCCIPITAL.....                                   | 27        |
| A.4b BASIOCCIPITAL .....                                   | 28        |
| A.4c EXOCCIPITAL.....                                      | 29        |
| A.4d EPIOCCIPITAL .....                                    | 30        |
| II.A.5 OTOLITHS .....                                      | 30        |
| II.B. DERMOCRANIUM .....                                   | 31        |
| B.1 DORSOCRANIUM.....                                      | 31        |
| B.1a FRONTAL .....   | 31        |
| B.1b NASAL.....  | 33        |
| B.1c EXTRASCAPULARS .....                                  | 33        |
| B.1d SUPRAPREOPERCLES .....                                | 34        |
| II.B.2 BASICRANIUM .....                                   | 34        |
| B.2a PARASPHEOID.....                                      | 34        |
| B.2b BASISPHEOID .....                                     | 35        |
| B.2c VOMER .....   | 35        |
| II.B.3 CIRCUMORBITAL SERIES.....                           | 36        |
| B.3a LACRYMAL.....   | 37        |
| II.3 SPLANCHNOCRANIUM.....                                 | 37        |
| C.1 SUSPENSORIUM .....                                     | 38        |
| C.1a PALATINE.....   | 38        |
| C.1b ECTOPTERYGOID .....                                   | 39        |
| C.1c METAPTERYGOID.....                                    | 40        |
| C.1d HYOMANDIBULAR.....                                    | 40        |
| C.1e QUADRATE .....  | 41        |
| C.1f PREOPERCLE.....                                       | 42        |
| II. C.2 UPPER MANDIBLE.....                                | 43        |
| C.2a PREMAXILLA.....                                       | 43        |
| C.2 b MAXILLA.....   | 43        |

|                                     |     |
|-------------------------------------|-----|
| II.C.3 LOWER MANDIBLE .....         | 44  |
| C.3a DENTARY .....                  | 44  |
| C.3b ANGULAR .....                  | 45  |
| C.3c RETROARTICULAR .....           | 46  |
| C.3d CORONOMECKELIAN .....          | 46  |
| II.C.4 HYOID ARCH .....             | 47  |
| C.4a HYPOHYALS .....                | 48  |
| C.4b CERATOHYAL .....               | 48  |
| C.4c EPIHYAL .....                  | 49  |
| C.4d INTERHYAL .....                | 50  |
| C.4e UROHYAL .....                  | 50  |
| II.C.5 BRANCHIAL APPARATUS .....    | 51  |
| C.5a BASIBRANCHIALS .....           | 52  |
| C.5b HYPOBRANCHIALS .....           | 52  |
| C.5c CERATOBANCHIALS .....          | 53  |
| C.5d EPIBRANCHIALS .....            | 53  |
| C.5e PHARYNGOBRANCHIALS .....       | 53  |
| C.5f DENTAL PLATES .....            | 54  |
| C.5g GILL RAKERS .....              | 54  |
| II.D. VERTEBRAL COLUMN .....        | 55  |
| D.1 WEBERIAN APPARATUS .....        | 56  |
| D.2 CAUDAL SKELETON .....           | 60  |
| D.3 RIBS .....                      | 61  |
| II.E OPERCULAR SERIES .....         | 62  |
| E.1 OPERCLE .....                   | 62  |
| E.2 INTEROPERCLE .....              | 63  |
| E.3 BRANCHIOSTEGAL RAYS .....       | 64  |
| II.F PECTORAL GIRDLE .....          | 64  |
| F.1 CORACOID .....                  | 65  |
| F.2 POSTTEMPORAL .....              | 66  |
| F.3 CLEITHRUM .....                 | 68  |
| F.4 RADIALS .....                   | 70  |
| F.5 PECTORAL SPINES .....           | 70  |
| II.G PELVIC GIRDLE .....            | 73  |
| II.H DORSAL SPINE .....             | 74  |
| II.I PTERYGIOPHORES .....           | 75  |
| I.1 Dorsal fin pterygiophores ..... | 75  |
| I.2 Anal pterygiophores .....       | 76  |
| III. BIBLIOGRAPHY .....             | 77  |
| IV. APPENDICES .....                | 86  |
| IV.I APPENDIX I .....               | 86  |
| IV.II APPENDIX II .....             | 122 |

# List of Figures

Fig. 1. Neurocranium. Dorsal view

Fig. 2 Neurocranium. Ventral view

Fig. 3. Neurocranium. A. Lateral view. B. Posterior view

Fig. 4. Neurocranium. A. Dorsal view. Dimensions. B. Lateral view. Dimensions

Fig. 5. Ethmoid. A. Dorsal view. B. Ventral view. Articulations. C. Lateral view. D. Dimensions

Fig. 6. Lateral ethmoid. A. Dorsal view. B. Ventral view. Margins. C. Articulations. D. Dimensions

Fig. 7. Orbitosphenoid. A. Dorsal view. B. Ventral view. C. Lateral view. Articulations. B and D. Dimensions

Fig. 8. Pterosphenoid. A. Lateral view. B. Mesial view. C. Articulations. D. Dimension.

Fig. 9. Sphenotic. A. Dorsal view. Articulations. B. Dimensions. C. Prootic. Lateral view. Articulations. D. Mesial view. Margins

Fig. 10. Pterotic. A. Extrascapulars and dorsal suprapreopercle. Dorsal view. Articulations. B. Ventral view. Articulations. C and D. Epioccipital. Lateral and ventral views

Fig. 11. Supraoccipital. A. Dorsal view. B. Ventral view. C. Articulations. D. Dimensions

Fig. 12. Basioccipital. A. Dorsal view. B. Dimensions. C. Exoccipital. Lateral view. D. Articulations

Fig. 13. Otoliths. A. Lapillus. Lateral view. B. Asteriscus. Mesial view. C. Sagitta. Dorsal view

Fig. 14. Frontal. A. Dorsal view. B. Ventral view. Ventral articulations. C. Dorsal articulations. D. Dimensions

Fig. 15. Parasphenoid. A. Dorsal view. Dimensions. B. Vomer. Dorsal view. C. Ventral view. Dimensions. D. Circumorbitals. Lateral view

Fig. 16. Palatine. A. Lateral and mesial views. B. Ectopterygoid and Metapterygoid. Lateral view. Articulations. C. Mesial view. Margins

Fig. 17. Hyomandibular. A. Lateral view. B. Mesial view. C. Articulations. D. Dimensions

Fig. 18. Quadrate. A. Lateral view. B. Mesial view. Dimensions. C. Articulations. D. Preopercle. Lateral view. Articulations and dimension

Fig. 19. Premaxilla. A. Dorsal view. B. Ventral view. Maxilla. C. Articulations

Fig. 20. Dentary. A. Lateral view. B. Mesial view. C. Articulations. D. Dimensions



Fig. 21. Angular and Retroarticular. A. Lateral view. B. Mesial view. Articulations. C. Dimensions. D. Coronomeckelian. Mesial view

Fig. 22. Hyoid arch and Branchiostegals rays. A. Lateral view. B. Mesial view. Dimensions. C. Urohyal. Dorsal view. Dimensions. D. Urohyal. Ventral view. E. Urohyal. Lateral view

Fig. 23. Branchial arches

Fig. 24. Weberian apparatus. A. Dorsal view. Dimensions. B. Lateral view. Dimension.

Fig. 25. Weberian ossicles. A. Claustrum. Lateral view. B. Scaphium. Lateral view. C. Intercalarium and Tripus. Ventral view

Fig. 26. Vertebral column. A. 6th precaudal vertebra. Frontal and lateral views. B. 11th precaudal vertebra. Frontal and lateral views. C. First caudal vertebra. Frontal and lateral views

Fig. 27. Caudal skeleton

Fig. 28. Opercle and ventral suprapreopercle. A. Dorsal view. B. Interopercle. Opercle articulations. C. Dimensions

Fig. 29. Coracoid and Radials A. Ventral view. B. Dorsal view. Margins. C. Articulations. D. Dimensions

Fig. 30. Posttemporal. A. Dorsolateral view. B. Dorsomesial view. C. Articulations. D. Dimensions

Fig. 31. Cleithrum. A. Lateral view. B. Mesial view, bone lying flat. C. Articulations. D. Dimensions

Fig. 32. Pectoral spine. A. Dorsal view. B. Dimensions Fig. 33. Pelvic girdle. A. Dorsal view. B. Ventral view. Dimensions

Fig. 34. Dorsal spine and dorsal pterygiophores. A. Dorsolateral view. Dimension. B. Frontal view. Ca and Cb. Dorsal view

Fig. 35. Anal pterygiophores

# I. INTRODUCTION

Catfishes, so-named because of the barbels associated with the mouth and the nasal regions, form a natural group of fishes characterized by the presence of the Weberian apparatus, spines on the pectoral and dorsal fins, and an adipose fin in the majority of species. Their number has been estimated at 2,584 species representing 32% of freshwater fishes in the world (Teugels 1996).

Catfishes are distributed densely on tropical and subtropical waters in Africa, South East Asia, and America from Argentina and Chile to Canada. Ictalurids are restricted to North America (Lundberg 1975), Canada being the northernmost area of expansion of this group.

According to Scott and Crossman (1973) catfishes are represented in Canada by two genera with seven species: *Ictalurus* (*melas*, *nebulosus*, *natalis*, and *punctatus*) and *Noturus* (*flavus*, *gyrinus* and *miurus*), throughout Nova Scotia, New Brunswick, southern Quebec, Ontario, Manitoba, and southeastern Saskatchewan. The brown bullhead is the only ictalurid species present in Nova Scotia.

Two subspecies have been recognized for *A. nebulosus*: *A. n. nebulosus* present in Canada and in the United States down to Virginia, Ohio Valley, and North Dakota and *A. n. marmoratus* occurring to the south of these areas (Hubbs and Lagler 1958).

Scott and Crossman (1973) state that *A. nebulosus* occurs in mainland Nova Scotia only, but samples at the NSM in Halifax extend its range to the whole area of Cape Breton.

To avoid repeating here the information about the importance and state of osteological studies for biologists and archaeologists refer to Rojo (Nova Scotia Museum Curatorial Report 96).

## I.1 Systematic position of *Ameiurus nebulosus*

The current status of the brown bullhead, subject of the present study, is *Ameiurus* (Rafinesque 1820) *nebulosus* (Lesueur, 1819). Agassiz (1846) erroneously amended the genus name given by Rafinesque (1820) to *Amiurus* (Ferraris, C. J., Jr. 2007). Scott and Crossman (1973) listed the changes undergone since LeSueur (1819) described it as *Pimelodus nebulosus*. Most North American systematists still use the binomial name *Ictalurus nebulosus*, but some use a trinomial *Ictalurus* (*Amiurus* [= *Ameiurus*]) *nebulosus* (Baumgartner 1982; Lundberg 1982). In this last case, *Amiurus* [= *Ameiurus*] is a subgenus of *Ictalurus*.

## I.2 Objective

The main objective of this work is to offer a complete, precise, and illustrated study of the skeleton of *A. nebulosus* as a guide for biologists interested in intra-

or interspecific comparative osteological work and for archaeologists wanting to obtain biological information from archaeological remains. A secondary application of this work refers to the study of the diet of predators (fish, birds, mammals) feeding on small bullheads, since juvenile and adult specimens would probably be spared thanks to their spiny defense mechanism.

### **I.3 History of bullhead's osteological studies**

The following osteological study refers exclusively to the brown bullhead from Nova Scotia. Up to the present time, no complete anatomical or comprehensive life-history study has been done for the brown bullhead from Nova Scotia waters.

The first osteological work in Canada, *The Osteology of Amiurus catus* (McMurrich 1884) refers to the author's material as "of our common Canadian Siluroid, *Amiurus catus*" at a time when *catus* and *nebulosus* were considered synonymous. Since *catus* has never been reported in Canada, there is still some doubt about the identity of the species studied by McMurrich. His drawings, done free hand, are not accurate enough for comparative purposes. Wright (1884) also describes the Weberian ossicles of "our commonest Siluroid *Amiurus catus*." McAllister (1968) provided data on the number of branchiostegal rays of *Ictalurus nebulosus*. Cumbaa (1978) prepared keys to identify 16 bones of *Ictalurus nebulosus*, *Ictalurus punctatus*, and *Noturus flavus*.

Scott and Crossman (1973) added some meristic data "based on Canadian material from New Brunswick to Ontario and, where possible as far west as British Columbia," but without indicating their precise geographical origin. They reported information on the numerical characters: "fewer vertebrae to the west (24-25) as compared to Ontario and east (36-39)," but they did not say whether or not they included the vertebrae forming the Weberian apparatus, although it is likely that they did; branchiostegal rays, 8-10; gill rakers, usually 9 on "upper limb" of the first branchial arch and 4-5 on "lower limb." Obviously, this is a typographical error, an error repeated by Jones et al. (1978). It should be 9 on the lower and 4-5 on the upper limb. Brousseau (1976) described in detail the anatomy of the pectoral girdle of *I. nebulosus*.

Elsewhere, the literature on *nebulosus* is more abundant, but no work deals with the whole skeleton. Kindred's (1919) work, titled *The skull of Amiurus*, refers in the text to *Amiurus nebulosus (catus)*, although by this time both species were already accepted as two separate species. He completed McMurrich's work on the skull, except for the branchiocranium and the pectoral girdle. Both works are worth studying, although their osteological nomenclature is outdated. Moreover, they are of limited value for archaeologists. Matveiev (1929) studied the development of the Weberian apparatus of *Amiurus nebulosus*. De Beer (1937) re-described Kindred's material and named it *Ameiurus nebulosus*. Smith (1956) compared the neurocranium and Weberian apparatus of 25 ictalurids in a succinct manner. She has no doubts about the identity of the material used by McMurrich and Kindred as being *I. catus*. Paloumpis (1963, 1964) studied the pectoral spine and Calovich and Branson

(1964) the supraethmoid bone of *I. nebulosus*. Jenkins (1977, 1979) dealt with the otic chambers, sacculus, and lagena of the brown bullhead. Lundberg (1982) provides observations on the palatine, the opercle, the urohyal, the pelvic girdle, and the number of rays of the anal fin of *I. nebulosus*. Lundberg (1992) gives an illustration of the metapterygoid without description. Lundberg and Baskin (1969) described the pattern of the hypurals.

Even in extensive papers on siluroids (Bridge and Haddon, 1889; Arratia, 2003a and 2003b; Diogo, 2000, and Alexander, 1964 and 1965) there are no specific references to *A. nebulosus*.

#### **I.4 Material and Methods**

The specimens studied in this work were captured with minnow traps at the following Nova Scotia localities:

- a) St. Mary's River Watershed, Guysborough Co. # 87471 to #87475; #87477; #87479 to #87482), 10 specimens with total lengths ranging from 135.5 to 155.9 mm,
- b) Medway River Watershed, Queens Co. #87919 - 87926, #87824, #87825, #88122, #88123), 12 specimens with total length ranging from 130.9 to 274 mm,
- c) Noel Lake, Hants Co. #11270 (TL = 187mm), and
- d) #1 and #2 (295 and 270 mm, total length, respectively) from the Shubenacadie River at Enfield (Hants).

Some skeletons were cleaned by dermestid beetles (#87471 to #87482, #87919 to #87927, #87824, #88122 and #88123) and others by maceration and dissection (#11270, #87825) on alcohol preserved specimens.

Data on various morphometric characteristics, other than total and standard lengths, weight, and sex, were also taken from fresh specimens for the study of the life history of the brown bullhead. The articulated and disarticulated skeletons are stored dry in individual plastic boxes at the Nova Scotia Museum of Natural History of Halifax for further reference.

Morphometric osteological data provided in this work refer to the left bone for paired bones. In the rare cases when the left bone was unavailable, the right one was measured, since after sporadic checks it was assumed that there is no significant difference between both side bones. Measurements were made with a caliper with an approximation of 0.1 mm.

Numerical data on the following meristic characters were also taken: gill rakers of the first left branchial arch; branchiostegal rays, and precaudal and caudal vertebrae.

The value of each measurement is given at the end in Appendix II for the benefit of researchers interested in comparing their data with ours. Correlation coefficients and regressions formulae were calculated between each dimension and the total length of the live fish.

Since the tables also give the regressions coefficients between the total and the standard lengths, it is possible to correlate each dimension with the standard length when only the standard length is available. No correlation values were calculated for the relationship total fish length with total fish weight, because of the small size of many specimens. This correlation can be easily obtained from the data provided.

## I.5 Bone nomenclature

It is a common complaint among biologists entering the field of fish osteology and archaeologists dealing with fish remains that the osteological nomenclature of fishes is in a chaotic state. One reason for this situation is the immense diversity of fish species that surpass all the remaining vertebrate species combined. The problem in osteological studies is the difficulty in homologizing the bones of such a variety of fishes with the corresponding ones in higher vertebrates. Embryological studies have tried to solve the problem, but the result has been a proliferation of new names, often not agreed upon by specialists.

For the nomenclature of *A. nebulosus* bones, I follow the trend of most workers in this field, which, we must admit, is still very controversial with such a plethora of theories, interpretations, opinions, and uses, that make it impossible to acknowledge them in the present work. Fish osteological nomenclature is still, to put it mildly, in a state of chaos, as a glance at specialized papers (Starks 1901; Weitzman 1962; Nelson 1969; Jollie 1986) will prove. Due to the large number of bones in the numerous species of fishes, extant and fossil, it is an almost insurmountable task to homologize the bones of fishes with those of higher vertebrates. This criterion was the guiding principle in the studies of early anatomists most of which were trained physicians.

In this paper, as in previous works (Rojo 1988, 1991), the names were selected according to the following guideline. Each bone should have one single name: palatine, ethmoid, etc. Double "rooted" names, such as autopalatine and supraethmoid, could easily be replaced by palatine and ethmoid, respectively, without creating any nomenclatural problem. It is, obviously, of great interest to know about their double ontogenetic origin, but compound bi- or trinomial terms referring to their double or multiple embryonic origin were avoided here.

This convoluted approach has produced binomial or even trinomial terms such as, *angular+articular+retroarticular* (Arratia 2003a) and *dentalo-splennial-mentomandibular* (Holmgren and Stensiö 1936) <sup>1</sup>.

The problem with trying to homologize *ad infinitum* and, consequently, *ad nauseam* can be appreciated with a modern example. It has been pointed out

---

<sup>1</sup> This approach is reminiscent of the political solution to break the stalemate when looking for a name for the new Republic of Macedonia (1992). Some proposed to call it FOPITGROBBSOSY, that stands for Former Province of Illyria, Thrace, Greece, Rome, Bizantium, Bulgaria, Serbia, Ottoman (Empire), Serbia, and Yugoslavia. <sup>1</sup>

long ago that the frontal bone of fishes is homologous to that of the mammalian parietal. In relation to this fact, we read in Arratia (2003a, page 16, line 14) that: “the frontal bones [= parietals]...” and in the next line “... (the frontals) ...are...longer than the parieto-supraoccipitals...” So, here we have two interpretations of the term parietal, one homologizing it to the frontal and another suggesting that the parietal fused in ontogeny with the supraoccipital. Obviously, this bone cannot be in two places. When describing the supraoccipital (page 15, line -8), Arratia (2003a) had replaced the term supraoccipital, with the term *parieto-supraoccipital* and in turn, she makes this last term synonymous to the *postparieto-supraoccipital*. Now, we have a new concept: the parietals are also the postparietals.

True, some authors consider the frontal bone of the fish as homologous to the mammalian parietal. Then, the parietals of fishes should be named postparietals. If this solution is accepted, the name “frontal” has to be discarded, a solution rejected by most authors, as too drastic, since this term has a long and universal tradition. Besides, there is a school of Fish Paleontology (Jarvik, 1967) supporting the interpretation of the homology between the fish frontal and the mammalian frontal.

## **I.6 Definition and Description of bones**

The description of each bone includes, when possible, observations about its nature, position in the body, function, important morphological and anatomical features, evolution and ontogenetic origin as applicable, and connections with adjacent bones.

A word of caution is pertinent here. Since the total range of our specimens extends from 128.2 mm to 295 mm in total length, some observations might differ from other descriptions when referring to smaller or larger individuals. A case in point is the disappearance by fusion of small bones in the cranium, such as suprapreopercles, extrascapulars, etc.

## **I.7 Synonymy of bone names**

The synonyms offered in this section regarding bone names are mostly those used by researchers dealing with Siluriformes, with emphasis on those dealing directly with Ameiuridae and close siluroid families. When a name has been used extensively for other orders of fishes than Siluriformes, I consider advisable to use it also for Siluridae, instead of adding a less known name. Most names selected here were those already selected before (Rojo 1988, 1991).

This section is addressed to biologists, ecologists, paleontologists, archaeologists, and people dealing in fish osteology.

## **I.8 Osteometry**

Two criteria have been accepted for selecting bones to be measured. For biological comparative studies of intraspecific and interspecific populations, I selected those bones that have a more significant value from the systematic point of view. For archeological work, I chose the well-ossified, thick, and large bones, since they can better resist the taphonomic influence of animal and climatic stress. The measurements taken from them will be more useful in obtaining information about the live fish. The bones most likely to be found in archaeological sites due to their size and consistence, besides the neurocranium complex and Weberian apparatus, are: the supraoccipital, basioccipital, parasphenoid, cleithrum, coracoid, dorsal spine, pectoral spines, posttemporal, hyomandibular, and opercle.

## **I.9 Illustrations**

Every bone of the brown bullhead skeleton is represented at least once. The drawings are generally oriented as they are placed in the fish, as the fish lay on their right side with their head(s) to the left. When warranted, two drawings, the mesial and lateral or the dorsal and ventral faces, showing the most important anatomical landmarks typical of the species are offered. A third drawing indicates the areas of articulation with adjacent bones, and a fourth shows the measurements selected.

All drawings were made by the author, to scale and by free hand; small details were checked with a stereoscope microscope with a 20x magnification. Due to the small size of otoliths and Weberian ossicles, photographs were taken with an SEM electron microscope LEO 1450 VP, with a high voltage of 10 kv and working distance of 30 mm at Saint Mary's University's Electron Microscopy Centre (Halifax, Canada).

## **I.10 Biometric study**

This last section offers 29 tables with the dimensions selected and the data obtained from each specimen. Two more tables deal with the meristic characters. The reason for presenting this information is to offer other researchers the opportunity to use this material for comparative purposes with their own data. Regressions equations and correlation coefficients are also included.

## II. DESCRIPTION OF OSTEOLOGICAL UNITS

### II.A NEUROCRANIUM

#### Definition and Description

The neurocranium proper or braincase is the earliest evolutionary component of the vertebrate skull. The endochondral bones that make it up can be grouped, from front to back, into four sections: the ethmoidal region, related to olfaction; the sphenoid, related to sight; and the otic and the occipital, both directly related to hearing.

The corresponding bones present in *A. nebulosus* neurocranium are the ethmoid and lateral ethmoids in the ethmoidal region; the orbitosphenoid and pterosphenoids in the sphenoid region, and the pterotics, prootics, supraoccipital, exoccipitals, basioccipital, and epioccipitals in the oto-occipital region (Fig. 1, 2, and 3). Missing in *Ameiurus* are the myodomes, supraorbitals, opisthotics, intercalaries, and parietals. The parietals were lost or, most likely fused, to the supraoccipital (Bamford 1948; Lundberg 1975a).

The *A. nebulosus* neurocranium is well ossified even in small specimens. As a result, it is often found, in paleontological and archaeological field work, as a tight unit with several dermal bones intimately attached to it, i.e. the frontals and two extrascapulars on its roof and the vomer and parasphenoid at its base.

The dorsal face slants gradually forward from the occipital region, makes a shallow concave curve at the level of the orbitosphenoid region, slightly rises at the ethmoidal region and then turns downward at the level of the cornua, where its depth is minimal. The dorsal surface of the neurocranium expands laterally at four levels: at the ethmoidal cornua; at the lateral ethmoids tips; at the expansions of the sphenotics and the pterotics bones where it has its maximum width (Fig. 4). At the level of the eyes, the skull narrows.

Two slender fontanel, separated from each other by the epiphyseal bar, run along the middle line of the skull. The anterior, the smallest, is framed by the frontals and barely touches the ethmoid bone. It tapers anteriorly, while the second fontanel, bound by the frontals and supraoccipital, tapers towards the back. Posteriorly, the supraoccipital bone extends into a strong and wide process that ends in a more or less blunt spine which never reaches the first supraneural of the dorsal fin.

The dorsal bones of the neurocranium, especially the lateral ethmoids, frontals, pterotics, and supraoccipital, are strongly carved with ridges, grooves, and pits for muscle attachment.

The posterior facet of the neurocranium shows four large foramina (Fig. 3B): two open in the supraoccipital for the passage of the lateral branch of the accessory facial nerve (Kindred 1919) and, ventral to them, there are two foramina: the large *foramen magnum* framed by the two exoccipitals, and, ventral to it, the foramen that leads to the *cavum sinus imparis*. This second



foramen is framed dorsally and laterally by the exoccipitals, and ventrally by the basioccipital.

In a lateral view (Fig. 3A), the neurocranium shows several large foramina of different sizes and shapes: the anteriormost is the olfactory foramen excavated into the lateral ethmoid; next, the orbital foramen located among the frontal, the lateral ethmoid, and the orbitosphenoid; the optic foramen that allows passage of the optic nerve (II) is framed by the pterosphenoid, orbitosphenoid, and parasphenoid; and, posteriorly, the larger foramen for the trigemino-facial nerve (V and VII) surrounded by the pterosphenoid, sphenotic, prootic, and arasphenoid. Two last foramina are carved into the exoccipital (Fig. 3A), the smaller for the glossopharyngeal nerve (IX) and the larger for the vagus nerve (X).

The posterior temporal fossa is covered by the extrascapular (Alexander 1965), but remains as a small cavity filled with fatty tissue.

### **Synonymy**

epiphyseal bridge (Devaere et al. (2004)

### **Iconography**

McMurrich(1884) Plate 2. Figs. 1 and 2. *Amiurus (catus)*

Kindred (1919) Plate IV. Figs. 6 and 7. Plate V. Figs. 10 and 11. Plate VI. Figs. 15, 16 and 20. *Ameiurus nebulosus (catus)*

### **Osteometry**

#### **A Lengths (taken from dorsal view) Fig. 4A and Table 1**

- AF** Neurocranium dorsal length. Distance between the anterior border of the ethmoid and the posterior tip of the occipital spine.
- F1** Length of the anterior fenestra.
- F2** Length of the posterior fenestra.
- OO** Length of the occipital spine. Distance between the end of the posterior fontanel and the end of the occipital spine. (Due to the variable position of the little depression in the occipital, I have taken this distance from the most constant position of the end of the posterior fontanel).
- AB** Ethmoid to lateral ethmoid wing length. Distance between the anterior border of the ethmoid and an imaginary line running across the lateral ethmoid tips.
- AC** Ethmoid to sphenotic lateral projections length. Distance between the anterior border of the ethmoid and an imaginary line running across the middle of the lateral projections of the sphenotics.

- AD** Ethmoid to pterotic wing length. Distance between the anterior border of the ethmoid and an imaginary line running across the pterotic wing tips.
- AE** Ethmoid to epioccipital wing length. Distance between the anterior border of the ethmoid and an imaginary line running across the lateral expansions of the epioccipital tips.

**Cross references**

Yerger and Relyea (1968) called AF, *total dorsal length*.

**B. Widths (taken from dorsal view)** Fig. 4A and Table 2

- W1** Ethmoid width. Maximum width between the lateral borders of the anterior cornua.
- W2** Width at the lateral ethmoid wings.
- W3** Width at the sphenotic projections.
- W4** Width at the pterotic wings.
- W5** Width at the epioccipital tips.

**Cross references.**

Smith (1956, table I) calls #1, *dermethmoid width* and provides a mean of 272 as a ‰ of neurocranium ventral length for 4 specimens, with a range of 252-357mm.

Calovich and Branson (1964, fig. 2A) call #1, *total cornual width*. Yerger and Relyea (1968) call it *supraethmoid width*. (See ETHMOID). Smith (1956, table I) calls #4, *pterotic width* with a mean 560 as ‰ of neurocranium ventral length for 4 specimens, ranging from 539 to 573 mm.

**Lengths (taken from lateral view)** Fig. 4B and Table 2

- VL** Neurocranium ventral length. Distance between the anterior border of the ethmoid and the posterior rim of the basioccipital.
- VH** Neurocranium height. Distance between the most dorsal point and the most ventral border of the basioccipital.

**Cross references.**

Smith (1956, Table I) calls #1, *neurocranial length* and gives the values: N=4, range 50.5-56.0 mm, mean 53.1. Yerger and Relyea (1968) also called #1, *neurocranial length*.

Baumgartner (1982), following Lundberg (1970), calls #1, standard skull length the distance from the anterior edge of vomer to posterior edge of basioccipital for paleontological material.

### **Iconography**

Smith (1956) Plate XI

Smith (1962) Fig. 5

Calovich and Branson (1964) Fig. 4C.

### **Observation**

Drawings by McMurrich 1884, Smith 1956, and Smith 1962 cannot be used for reference in osteometric studies because there are not drawn to scale. Calovich and Branson (1964) drawings are acceptable.

## **II.A.1 ETHMOIDAL REGION**

### **A.1a ETHMOID**

#### **Definition and Description**

The ethmoid region has in Ictaluridae two bones, one preformed in cartilage, the ethmoid and the other, a membrane bone, the mesethmoid (dermethmoid). Since both bones have joined during their embryonic development, the resulting bone has received various names to reflect this fact. Here, it is called ethmoid as is the usage for most orders of fishes (Figs. 1, 2, 3, and 5).

The ethmoid presents on its anterior border a middle depression from which two symmetrical expansions, called cornua, curve laterad. The depression varies in width and depth in the different species of Ictaluridae. In our specimens it is wide and shallow.

Seen in lateral view, the ethmoid presents two laminae, one dorsal and the other ventral, that extend backwards from the body of the bone (Fig. 5C) These laminae represent the double origin of the bone: the upper dermal that extends laterally into two cornua or crests and splits backwards in two branches; the lower lamina, chondral in origin is much shorter. Both are joined by an expanded oblique lamina on each side, sometimes called posterior cornua (Fig. 5A).

This bone articulates anteroventrally with both premaxillae, laterally with the lateral ethmoids, posteriorly with both frontals, ventrally with the vomer. The nasals and, slightly the lachrymal, rest loosely on the dorsal face of the ethmoid.

Paloumpis (1963) provides measurements and ratios on this bone as diagnostic characters to identify species of the genus *Ameiurus*. Calovich and Branson (1964) also took some measurements but did not provide any numerical data.

**Synonymy** Lat. os ethmoideum (= os ethmoidale) Fr. ethmoïde

ethmoid Alexander (1965); Gauba (1966); Howes (1983)

derm-ethmoid Nawar (1954)

ethmoid-supraethmoid complex.

supraethmoid – ethmoid complex

Cumbaa (1978). De Beer (1937 [1971]) recognizes the different ontogenetic origin of ethmoid and the subsequent fusion with the supraethmoid. Calovich and Branson (1964) named the dorsal section of the bone, supraethmoid and the ventral part, ethmoid.

mesethmoid McMurrich (1884), but some drawings are labeled [Eth.]; Gregory (1933); Eaton (1948); Gosline (1975); Grizzle and Rogers (1976); Fink and Fink (1981); Lundberg (1991); Arratia (2003a); Thomas (pers. com.)

supraethmoid Kindred (1919); Paloumpis (1964); Mundell (1975); Lundberg (1982); Grande (1987)

mesial processes Lundberg (1970); Grande (1987)

ethmoid crests Cumbaa (1978) calls them posterior cornua

### **Iconography**

Paloumpis (1963). Fig 2E

Calovich and Branson (1964). Figure 4C

### **Osteometry** Fig. 5D and Table 3

**AB** Maximum ethmoid length. Distance between the anterior margin of the bone to its most posterior end.

**CD** Maximum ethmoid width. Distance between the outer borders of the cornua.

## Cross references

Paloumpis (1964) calls #1 “supraethmoid width.” Calovich and Branson (1964) call it “total cornual width,” and Thomas (pers. comm.) “anterior width.”

Paloumpis (1964) calls #2 “supraethmoid neck width,” while Baumgartner (1982) and Lundberg (1970) call it “minimum dorsal width” and Thomas (pers. comm.) “neck width.”

None of the authors quoted, gives individual specimen data of the measurements proposed above. Cumbaa (1978) offers for *Ictalurus nebulosus* the ratio “least ethmoid width / greatest width of anterior cornua” following Calovich and Branson (1964). These last authors studied only five specimens with a standard length varying between 214 and 263 mm.

## A.1b LATERAL ETHMOID

### Definition and Description

The lateral ethmoid is a paired bone of endochondral and membrane origin (Figs. 1, 2, 3 and 6). The body of the bone, formed at the expense of the ethmoid cartilage, extends laterally into a pointed process of dermal origin called antorbital process by McMurrich (1884).

The lateral ethmoid anterior margin is smooth and prolongs anteriorly into a prong which sutures ventrally with the vomer. At the base of the second prong there are several small foramina for the passage of branches of the olfactory nerve (Kindred 1919).

Its posterior margin forms a smooth arch that meets dorsally with the ethmoid and frontal, and ventrally with the orbitosphenoid. At the junction of the lateral ethmoid, where the frontal anterior border forms a deep flexure, the orbito-nasal foramen allows the passage of the superficial ophthalmic branch of nerve VII.

Dorsally, the lateral ethmoid meets the nasal and the lacrymal. Ventrally, there is an elongated and rough facet for the articulation with the palatine.

|                           |                             |                      |
|---------------------------|-----------------------------|----------------------|
| <b>Synonymy</b>           | Lat. os ethmoideum laterale | Fr. ethmoïde latéral |
| ectethmoid                | Kindred (1919)              |                      |
| parethmoid                | Grizzle and Rogers (1976)   |                      |
| prefrontal-parethmoid     | Cumbaa 1978 (in the Index)  |                      |
| prefrontal and parethmoid | Cumbaa 1978 (in the figure) |                      |

## **Iconography**

Cumbaa 1978                      Fig. 2

**Osteometry**      Fig. 6D and Table 4

- AB**            Maximum length. Distance between the anteriormost and the posteriormost points.
- CD**            Maximum width. Distance in a straight line between the tip of the antorbital process and the most posterior point of the bone.

## **II.A.2 ORBITOSPHEOID REGION**

### **A.2a ORBITOSPHEOID**

#### **Definition and Description**

The orbitosphenoid, an unpaired chondral bone, forms the floor and sides of the neurocranium sphenoid section (Figs. 2, 3 and 7). Its anterior margin is arched and smooth, while its posterior is straight. Both margins present spicules with which they suture with the lateral ethmoids and the parasphenoid.

Its dorsal surface shows many small pits on its posterior half. Along each wall, a shelf supports the optic nerve (Kindred 1919). On its ventral face, two slightly curved crests run along the whole length of the bone.

The orbitosphenoid rests fully on the dorsal surface of the parasphenoid. Dorsally, it barely meets the vomer, but articulates extensively, with the frontals and pterosphenoids. Its walls frame anteriorly the optic foramen and posteriorly, the trigeminofacialis foramen (Fig. 3).

**Synonymy**    Lat. os orbitosphenoideum      Fr. orbitosphénoïde

**Osteometry**    Fig. 7B and 7D and Table 5.

- AB**            Length. Distance between the most anterior and its most posterior border.
- CD**            Width. Distance between the most lateral borders.

## A.2b PTEROSPHEOID

### Definition and Description

The pterospheoid is a well-ossified paired bone of endochondral and dermal origin, located in the middle section of the neurocranium. Its strong ventral process separates the optic foramen, in front, from the trigemino-facial foramen, behind (Figs. 2, 3, and 8).

The dorsal margin of its lateral face is low vaulted; its anterior margin presents the characteristic spicules for its suture with the frontal and orbitospheoid; and the posterior margin, also serrated, matches a similar border in the sphenotic. The anterior section of the lateral face opens into a groove where the anterior process of the hyomandibular articulates. Its ventral margin is serrate and articulates with the alar expansion of the parasphenoid.

The smooth mesial face presents two foramina, one upper and small for the passage of the facial nerve and another lower and larger for the trigeminal (Kindred 1919).

|                 |   |                    |
|-----------------|---|--------------------|
| <b>Synonymy</b> | Lat. os pterospheoideum   | Fr. Ptérosphenoïde |
| alisphenoid     | Proposed by Huxley (1864); McMurrich (1884); Kindred; (1919); Gregory (1933); Grizzle and Rogers (1976) |                    |
| pleurospheoid   | de Beer (1937)  |                    |
| dermosphenotic  | Nawar (1954) [An inadvertent error?]  |                    |

**Osteometry** Fig. 8D and Table 6.

**AB** Length. Maximum distance between the most anterior and most posterior points.

## A.2c SUPRASPHENOID

### Definition and description

The suprasphenoid is an unpaired endochondral bone developed between the optic and the trigemino-facialis foramina. According to Kindred (1919) it soon joins and fuses with the margins of the parasphenoid and loses its identity. By all accounts, the suprasphenoid is synonym of the basisphenoid. This latter name, according to Kindred, is not homologous with the basisphenoid of mammals and therefore it should be rejected. The suprasphenoid was found, with some difficulty, in a few of our younger specimens in a cartilaginous or laminar bone condition.

|                 |                                  |                    |
|-----------------|----------------------------------|--------------------|
| <b>Synonymy</b> | Lat. os suprasphenoideum         | Fr. suprasphénoïde |
| basisphenoid    | McMurrich (1919); de Beer (1937) |                    |

## II.A.3 OTIC REGION

### A.3a SPHENOTIC

#### Definition and Description

The sphenotic is a paired endochondral bone formed on the roof of the neurocranium that bridges, as the name implies, the sphenoid and otic regions. In *A. nebulosus*, it articulates mesially by an interdigitating margin with the frontal, and posteriorly, with the supraoccipital and pterotic. Its lateral margin forms a groove, in line with a similar one in the pterotic, for the attachment of the hyomandibular. Ventrolaterally, the sphenotic joins anteriorly the pterosphenoid and ventrally the prootic (Figs. 1, 2, 3, and 9).

The dorsal face of the sphenotic is smooth. Midway, several openings allow the passage of branches of the facial nerve (VII). The branch of the lateral canal system is clearly detectable under the surface of the bone. A few sensory pores are present in small specimens, but disappear in larger specimens. Kindred (1919) does not show any pore in the illustration of this bone.

Close to the lateral border there is a large oval foramen, sometimes split into two, for the passage of the main branch of the facial nerve. The ventral surface shows a thick crest surrounded by three big cavities. In the middle cavity there is an opening that communicates with the foramen on the surface of the bone. The posterior cavity encloses the anterior semicircular otic canal.



The lateral margin forms a prominent bulge from which the margin recedes, forming a convex arch until it joins with the pterotic bone, where it expands laterally again.

|                 |  |                 |
|-----------------|--|-----------------|
| <b>Synonymy</b> | Lat. os sphenoticum                              | Fr. Sphénotique |
| sphenotic       | McMurrich (1884); Kindred (1919)                 |                 |
| postfrontal     | Cuvier (1825); Sagemehl (1885); McMurrich (1884) |                 |
| autosphenotic   |  |                 |

**Osteometry** Fig. 9B and Table 7

- AB** Length. Distance between the most anterior and most posterior points.
- CD** Width. Distance between the most lateral point of the outer margin and the most inner point of the mesial border.

### A.3b PROOTIC

#### Definition and Description

The prootic is a paired endochondral bone that covers the anterolateral part of the otic capsule (Figs. 2, 3, and 9). In lateral view, it has a pentagonal shape with straight anterodorsal, dorsal, posterior, and ventral margins. Its anteroventral margin is arched with two well defined sections, the upper with a few wide spicules that frame the posterior limit of the trigeminofacialis foramen, and the lower with numerous, thin spicules that suture with the parasphenoid alar expansion. Its outer surface is smooth and presents a large oval bulge corresponding to the *utriculus* chamber, the *recessus utriculi*, of the otic capsule.

The dorsal and posterior parts of the bone are thick and well ossified, while the anterior expansion is laminar. The inner face of the bone is smooth, with two big depressions separated by a large, curved wing of thin bone.

The prootic articulates with the sphenotic, the pterotic, and the exoccipital by narrow cartilaginous bands, with the exception of a bony laminar dentated band that connects with the pterotic. This bony band is well marked in older specimens, but also visible in the young.

Both prootics join in the middle line and rest on the basioccipital. Anteriorly, they suture with the parasphenoid and articulate with its corresponding pterosphenoid.

| <b>Synonymy</b> | Lat. os prooticum | Fr. Prootique |
|-----------------|-------------------|---------------|
| prootic         | Huxley (1864)     |               |
| petrosal        | Meckel (1824)     |               |
| ala magna       | Cuvier (1825)     |               |
| ala temporalis  | Stannius (1854)   |               |

### **A.3c PTEROTIC**

#### **Definition and Description**

The pterotic is a paired bone of mixed origin, since its autopterotic section is chondral, while its squamosal part is dermal (Figs. 1, 2, 3, and 10A and B).

It occupies the dorsal, lateral and posterior areas of the neurocranium. Its dorsal face is subtriangular with its posterior vertex curved and pointing backwards. Posteriorly, a thick, high crest runs mesially to join another similar one in the supraoccipital. This crest also joins anteriorly with the additional extrascapula (Arratia 2003a), a small bone located close to the lateral margin of the pterotic, clearly visible, even in young specimens (Fig 10A). The pterotic ventral face is hollowed out by several, more or less conical, deep cavities

According the Kindred (1919) the lateral line canal that develops above it, fuses completely with the pterotic, although leaving two pores still visible. In our specimens, the entrance and exit pores are visible below the heavily ossified dorsal face.

Posteriorly, the pterotic articulates with the dorsal process of the posttemporal and at the level of the suture of the petrosal and squamosal parts, with the dorsal suprapreopercle. It also sutures with the supraoccipital, the sphenotic, the prootic, and the epioccipital bones and articulates synchondrally with the epioccipital, exoccipital, the prootic, and the sphenotic. The hyomandibular fossa, carved on the anterior part of the upper margin of the pterotic, receives the anterior process of the hyomandibular.

| <b>Synonymy</b>   | Lat. os pteroticum                       | Fr. ptérotique |
|-------------------|--|----------------|
| pterotic          | McMurrich (1884) and most modern authors |                |
| squamoso-pterotic | Kindred (1919)                           |                |

## II.A.4 OCCIPITAL REGION

### A.4a SUPRAOCCIPITAL

#### Definition and Description

The supraoccipital is an unpaired mostly endochondral bone, that forms the roof of the otico-occipital region (Figs. 1, 2, 3, and 11). Although in many fishes it forms the dorsal part of the foramen magnum, in *Ameiurus nebulosus*, it barely touches it. This bone splits anteriorly, forming the second half of the posterior fenestra framed with raised borders for the attachment of the muscles of the opercular and mandibular groups. Posteriorly, the supraoccipital prolongs into the occipital spine, which is formed independently during embryogeny. Although sometimes called a crest (Arratia 2003a), it is more properly a spine, since it does not rise above the bone as in other fishes, and ends in a sharp point. The occipital spine does not reach in the brown bullhead the first supraneural of the dorsal fin, a feature that characterizes the subgenus *Ameiurus*, according to Jordan and Evermann (1896). The supraoccipital spine extends throughout its length into a vertical ventral lamina (Fig. 3A) that fits into the anteriormost bifid neural process of the Weberian apparatus.

The profusely serrated anterior and lateral margins of the supraoccipital suture with the frontals and both sphenotics. Laterally, the posterior margin is straight on both sides, but soon curves to join the occipital spine. The dorsal face is smooth anteriorly, but posteriorly presents pits and grooves, especially in older specimens. The spine also has some superficial foramina interpreted by McMurrich (1884) as part of the ramifications of the sensory line canal, an interpretation refuted by Kindred (1919). The mesial extrascapular bone of each side rests or simply touches the dorsal surface of the bone (Fig. 1).

Laterally, the supraoccipital bone sutures via thin layers of cartilage with the pterotics and ventrally joins the exoccipitals, epioccipitals and barely touches the posttemporals. On its posterior face, two large foramina pierce the bone allowing the passage of the lateral branch of the facial accessory nerve. These foramina reach the ventral surface of the bone. The ventral surface of the supraoccipital is smooth in front and thick, and well ossified at the back

**Synonymy**            Lat. os supraoccipitale            Fr. Supraoccipital  
parieto-supraoccipital    Arratia and Gayet (1995)  
postparieto-supraoccipital    Arratia (2003a)

## Osteometry Fig. 11D and Table 8

- AB.** Length. Distance between the most anterior and the most posterior borders.
- CD.** Length of the occipital crest. Distance between the posterior fenestra and the posterior tip of the occipital crest (Fig. 4A).
- EF** Width. Distance between the most lateral points of the bone.

### A.4b BASIOCCIPITAL

#### Definition and Description

The basioccipital is an unpaired chondral bone located in the most posteroventral area of the occipital region (Figs. 2, 3A, 3B, 12A, and 12B). Its dorsal face presents anteriorly several long furrows and spicules with which it sutures with the parasphenoid. Posterior to this section, there is on each side a trough, the *fovea sacculi*, that encloses the sacculus, which in turn encloses the otolith sagitta. Two symmetrical cavities, the *atria sinus imparis*, occupy the rest of the dorsal facet. In between these last troughs there is a laminar cup-like elevation with two walls and a central concavity, the *cavum sinus impar* (Fig. 3B). Laterally, two lateral small accessory processes project outward to join the ossified Baudelot's cartilages.

On its ventral face, the basioccipital presents two well-defined sections: the anterior, with similar long grooves and spicules as those on the dorsal face, and the posterior, the typical section of a vertebra with a small circular cavity, the nutrient foramen of McMurrich (Fig. 2). De Beer (1937) states that this bone fuses with the centrum of the first vertebra. In its final stage of the basioccipital development, the posterior part of this bone looks exactly like a half vertebral centrum, but this arrangement is common in many groups of fishes. At any rate, it is unacceptable to call "first vertebra" its posterior part, as some authors do. This supposed vertebra should never be included in the vertebral count.

In a posterior view, the bone presents a conical cavity whose margin (the basioccipital condyle) joins synchondrally the first vertebra of the Weberian apparatus.

The basioccipital articulates laterally with the exoccipitals and anteriorly abuts both prootics.

**Synonymy**                      Lat. os basioccipitale                      Fr. basioccipital

**Osteometry** Fig. 12B, 4B, and Table 9

**AB.**        Length. Distance between the most anterior and the most posterior points of the bone (Fig. 12B).

**CD**        Width. Distance between the most lateral borders of the bone (Fig. 12B).

**CD**        Width of the basioccipital condyle (Fig. 4B #1).

**AB**        Height of the basioccipital condyle (Fig. 4B #2).

### **Cross references**

Thomas (pers.com.) calls *width of the articular facet*, our width of basioccipital condyle.

## **A.4c EXOCCIPITAL**

### **Definition and Description**

The exoccipital is a paired chondral bone located at the side and back of the otico-occipital region that frames the foramen magnum on its side and bottom (Figs. 1, 2, 3A, 3B, and 12D).

The main anatomical landmarks on the lateral face are two foramina, the small anterior foramen for the glossopharyngeal nerve and the large foramen for the vagus nerve (Fig. 2 and 12C). Often both foramina coalesce into a larger one, so it is not rare to see one specimen with one foramen on one side and two on the other. On the posterior face of the exoccipital, which is deeply concave, another small foramen pierces the bone for the hypoglossus nerve (Kindred 1919).

From its mesial face, a shelf of bone projects inwards to meet a similar one from its antimere, forming in this way, the floor of the foramen magnum and the roof of the *sinus impar*.

The exoccipital articulates anteriorly with the prootic; ventrally, with the parasphenoid and basioccipital; dorsally, with the pterotic, the epioccipital and supraoccipital, and posteriorly, with the ossified Baudelot's cartilage. All articulations are of the synchondral type, although the anterior and dorsal margins show some spicules at the inner sides of the bone. All surfaces are smooth, except the rugose lower and posterior section where the muscles of the pectoral girdle attach.

**Synonymy**                      Lat. os exoccipitale                      Fr. exoccipital

lateral occipital

pleuroccipitale                      Gaup (1906)

#### A.4d EPIOCCIPITAL

##### Definition and Description

The epioccipital is a paired endochondral bone formed from the occipital arch cartilage. It has a triangular pyramidal shape with its vertex directed back and outward. It closes the otico-occipital capsule lateroposteriorly (Figs. 1, 2, 3, 10C and 10D).

The dorsal process of the posttemporal rests firmly on the dorsal face of the epioccipital. This bone articulates dorsally with the supraoccipital, pterotic, and mesial extrascapular. Ventromesially it joins with the exoccipital through several synchondroses.

|                 |   |                  |
|-----------------|---|------------------|
| <b>Synonymy</b> | Lat. os epioccipitale   | Fr. Épioccipital |
| epioccipital    | Patterson (1975) and most modern authors  |                  |
| epiotic         | Proposed by Huxley (1864); McMurrich (1884); Kindred (1919); Gregory (1933); Alexander 1965); Arratia (2003a) |                  |

#### II.A.5 OTOLITHS

##### Definition and Description

Although otoliths are not strictly speaking part of the skeleton, they are included here because of their calcareous nature and close association with the oto-occipital region bones.

The otoliths are lodged in membranous chambers collectively called, membranous labyrinth. The chambers, in turn, are encased in the cavities formed by the osseous labyrinth. The lapillus occupies the utricle; the sagitta, the sacculus; and the asteriscus, the lagena. In most fishes, the sagitta is usually the largest otolith, but in ostariophysans the lapillus is the largest.

The lapillus of *A. nebulosus* has its inner surface flat while the lateral is highly convex (Figs. 9D and 13A). It has an oval shape, in contrast with the one represented by McMurrich (1884) for *Amiurus catus*, which is clearly almond-shaped. The elongated sagitta (Figs. 12A and 13C) shows several parallel troughs or flutes and the asteriscus (Figs. 12A and 13B) has the characteristic circular shape.

Jenkins (1977, 1979) has described in detail the otic chambers (lagena and sacculus) and the otolith sagitta of *A. nebulosus*.

**Synonymy**      Lat: otolithus      Fr. Otolithe  
sagitta, sacculolith  
lapillus, utriculith, utricular otolith  
asteriscus, asterisk, lagenolith

### **Iconography**

Labyrinth Jenkins (1977) figs. 2 and 3  
Chardon, M. et al. (2003) figs. 1 to 3.6  
Sagitta Jenkins (1979) Plate 1(nos.1 and 2)

## **II.B. DERMOCRANIUM**

### **Definition and Description**

The dermal bones intimately associated to the original chondral bones of the skull form the dermocranium, which is presented here as an independent unit. Most of its bones are strongly joined to those of the chondrocranium, forming the neurocranium *sensu lato*. This complex unit is often found in one piece in paleontological and archaeological deposits.

Skull dermal bones associated to the chondral bones of the visceral arches are included in the Splanchnocranium.

### **B.1 DORSOCRANIUM**

#### **B.1a FRONTAL**

### **Definition and Description**

The frontal is a paired, dermal bone that occupies the largest part of the dorsal surface of the neurocranium (Figs. 1, 2, 3A, and 14). In *A. nebulosus*, the frontal is wider at its anterior end and narrow at the back. Its anterior margin presents a large trough that converges with another on its corresponding lateral ethmoid with which the frontal sutures. Both bones contribute to the formation of the foramen for the passage of the ophthalmic superficial branch of the nerve VII (Fig. 1 and 14A and 14B). Parallel to the anterior fontanel there is a section of the supraorbital sensory canal with two or three pores embedded in the frontal.

Almost at mid length, both frontals join mesially via a narrow expansion, the epiphyseal bridge, the result of the ossification of the hypophyseal bar of the embryo. Two narrow fontanels open, one in front and the other behind this bridge. The anterior, the shorter, which tapers towards the front where it meets the ethmoid, is framed almost entirely by both frontals. Between the anterior fontanel and the fused supraorbital canal bone there is a strong crest running the whole length of the frontal and joining a similar one in the supraoccipital. The posterior fontanel tapers towards the back and it is framed anteriorly by both frontals and posteriorly by the supraoccipital.

Also on the dorsal surface, the frontal presents laterally a long, strong crest for the attachment of the *adductor mandibularis* muscle. The entire dorsal surface is profusely sculptured with pits, foramina, and branching grooves of variable depth that spread over the supraoccipital.

In lateral view, the frontal presents a shelf of bone that meets anteriorly the crest above mentioned and posteriorly joins and overlaps the sphenotic. Mesial to this shelf, there is another shorter and wider crest that meets the orbitosphenoid and pterosphenoid. The lateral border meets the Dermosphenotic, from the circumorbital series.

**Synonymy**            Lat. os frontale            Fr. frontal

(The frontal, in spite of having been homologized to the mammalian parietal, has retained its name in osteological nomenclature, a situation that could be followed for other bones to avoid the continuous and confusing flux of names due to discordant opinions.)

fontanel, fontanelle

posterior fontanelle            Kindred (1919)

first fontanel                    Ethmo-frontal fontanel Gauba (1966)

posterior fontanel            Fronto-occipital fontanelle Gauba (1966)

**Osteometry**    Fig. 14D and Table 10

**AB**            Length. Distance between the most anterior and the most posterior points of the bone.

**CD**            Width. Distance between the most lateral points of the bone.



## B.1b NASAL

### Definition and Description

The nasal is a paired dermal bone formed from connective tissue at the roof of the olfactory capsule. It is a small flat bone rounded on both ends with a small expansion on its lateral margin (Fig. 5A). A sensory canal with three pores runs along its length, one pore at each end and a third at its lateral expansion. The nasals overlap the ethmoid posterior cornua.

**Synonymy**      Lat. os nasale              Fr. nasal

## B.1c EXTRASCAPULARS

### Definition and Description

The extrascapulars, dermal bones related to the sensory canal system, are located in the temporo-occipital region of the skull. *Ameiurus nebulosus* has two extrascapular bones: one, the lateral extrascapular, close to the posterolateral margin of the neurocranium with its sensory canal clearly visible (Figs. 1 and 10A), while the other, the “additional extrascapula” of Arratia (2003a) has no sensory canal (Figs. 1 and 2). It is called here “mesial extrascapular.” Both extrascapulars connect with the pterotic, epioccipital, and posttemporal, but the mesial extrascapular also touches the supraoccipital. Lundberg (1975) calls both, posttemporal, to indicate that they are two ossifications of the same bone, the laterosensory posttemporal, in a lateral position, and the lamellar posttemporal, in a medial position.

Both bones, clearly visible in small and medium size specimens, have small grooves and pits typical of dorsal cranial bones. In older specimens, they often fuse with adjacent bones and are difficult to recognize. Neither McMurrich (1884) nor Kindred (1919) mentioned them in their studies of the skull, although Kindred drew the lateral extrascapular in Plate V, fig. 10.

### Synonymy

|              |                          |
|--------------|--------------------------|
| posttemporal | Lundberg (1975b)         |
| extrascapula | Arratia and Gayet (1995) |

Rojo (1988, 1991) gave the following list of synonyms: tabulars, scalebones (Gregory 1933), supratemporals (Owen 1848), extrascapulars, cervicals, nuchals, and postparietals. We add here, cervicals, parietals, supratemporals, and posttemporals, from Arratia and Gayet (1995).

## B.1d SUPRAPREOPERCLES

### Definition and Description

The suprapreopercles are small, membrane bones corresponding to the opercular lateral line branch of the sensory canal system. There are only two in *A. nebulosus*. The dorsal (Fig. 10A) is the largest and connects with the pterotic bone where the petrosal and squamosal parts of the pterotic meet. The ventral and smaller suprapreopercle (Fig. 28A) is attached to the preopercle and rests on the articular process of the opercle. These bones are not tubular, as is common in sensory bones, but they form a groove with its dorsal part covered by a thin layer of tissue.

### Synonymy

supratemporals                      Parker (1874)

subtemporals                        Ridewood (1904); Sagemehl (1885); Kindred (1919)

## II.B.2 BASICRANIUM

### B.2a PARASPHEOID

#### Definition and Description

The parasphenoid is a median, dermal bone that lines the neurocranium from the ethmoid region to the occipital. Its two more prominent features are a long, strong shaft and two lateral alar expansions at about two thirds from its anterior end. The bone is smooth and slightly curved upward at both ends, so its dorsal upper facet is clearly concave at the level of the alar expansions (Fig. 15A).

This bone splits into long and parallel spicules at both ends: its anterior spicules meet the ethmoid and the dorsal facet of the vomer, so that this last bone remains ventral to the parasphenoid. Its posterior spicules, on the contrary, overlap the underside of the basioccipital. At its anterior end, this bone also synchondrally contacts the lateral ethmoids. The alar expansion margins have many spicules with which this bone sutures with the orbitosphenoid, the prootics, and the pterosphenoids. These last bones meet the parasphenoid alar expansions, thereby separating the optic from the trigeminofacialis foramen.

The fact that the parasphenoid links so many bones underscores its supporting function for the orbit, otic, and occipital regions of the neurocranium.

**Synonymy** Lat. os parasphenoideum Fr. parasphenoïde

**Osteometry** Fig. 15A and Table 11

**AB** Length. Distance between the most anterior and its most posterior end.

**CD** Width of the body. Distance between the two most lateral points of the alar expansions.

### **B.2b BASISPHENOID**

#### **Definition and Description**

The basisphenoid is an unpaired endochondral bone described by McMurrich (1884) as a flattened structure ankylosed to the parasphenoid, forming part of the bases of the optic and trigeminal foramina. It was not discernible in our specimens (See SUPRASPHENOID).

**Synonymy** Lat. os basisphenoideum Fr. basisphénoïde

### **B.2c VOMER**

#### **Definition and Description**

The vomer is a dermal bone located at the base of the neurocranium and related to the ethmoidal region. Originally a paired bone, has become a single bone in most modern fishes (Fig. 2, 3, 15B, and 15C). In *A. nebulosus*, the vomer is a flat and laminar bone that lines the anterior part of the roof of the fish palate. Anteriorly, the vomer expands into a large almost rectangular lamina with dentated margins which sutures with the ethmoid and the lateral ethmoids. Posteriorly, the bone prolongs into a long process that tapers into two pointed spicules with which it intimately articulates with the parasphenoid. Laterally, it sutures with the orbitosphenoid.

**Synonymy** Lat. os vomere Fr. Vomer  
prevomer Harrington (1955); Daget (1964)

**Osteometry** Fig. 15C and Table 12

**AB** Width. Distance between the two most lateral borders of the bone's head.

## II.B.3 CIRCUMORBITAL SERIES

### Definition and Description

The circumorbitals are dermal bones formed around the sensory canal that completely surround the eye orbit. They can be split into four groups that, in a clockwise order, can be named, antorbitals, supraorbitals, postorbitals, and infraorbitals.

In *A. nebulosus*, this series is incomplete since the antorbitals and supraorbitals are missing and the remaining bones have significantly been reduced in size (Fig. 15D). The circumorbitals present are called infraorbitals following most authors and are represented as IO<sub>1</sub> to IO<sub>7</sub>, starting with the lacrymal (IO<sub>1</sub>) and followed by the jugal (IO<sub>2</sub>).

This series articulates anteriorly with the lateral ethmoid through the lacrymal and posteriorly with the frontal via the seventh bone, the dermosphenotic. Each one of the infraorbitals, in turn, articulates with each other.

McMurrich (1884) reports for *A. catus*, six bones, and count them starting from the one at the posterior dorsal location, our seventh, and follows down and forward without assigning them any name or number. His adnasal, not included in his series, is clearly our lacrymal, so his total number is also seven.

Lundberg (1982) names the first of the "infraorbitals series" lacrymal and reports the total number to be six for *Trogloglanis pattersoni*, a number he considers to be the primitive condition for Ictaluridae. His figure 29 shows *Ameiurus mexicanus* with six infraorbitals and *A. catus* with seven.

### Synonymy

|  |   |
|--|---|
| IO <sub>1</sub> lacrymal                       | Kindred (1919); Gauba (1966); Grizzle and Rogers (1976); Lundberg (1982) and most authors |
| IO <sub>1</sub> adnasal                        | McMurrich (1884)  |
| IO <sub>1</sub> antorbital                     | Sagemehl (1883); Gauba (1966); Arratia and Huaquín (1995)                                 |
| IO <sub>1</sub> antorbital                     | Berg (1940)   |
| IO <sub>2</sub> lacrymal                       | McMurrich (1884)  |
| IO <sub>2</sub> jugal                          | Nawar (1954); Grizzle and Rogers (1976)   |
| IO <sub>1</sub> - IO <sub>3</sub> suborbitals  | Kindred (1919)  |
| IO <sub>4</sub> - IO <sub>5</sub> postorbitals | Kindred (1919)  |
| IO <sub>6</sub> postfrontal                    | Allis (1898); Kindred (1919)  |
| The last one dermosphenotic                    | Parker (1874)   |

### B.3a LACRYMAL

#### Definition and Description

The lacrymal is a paired dermal bone belonging to the infraorbital series. It is the most anterior and largest of the series in many fish species, but in Ictaluridae it is small and thin (Fig. 15D). It covers the lateral side of the nasal capsule. Its body, small and laminar, expands into four processes: the anterolateral, slender and curved; the median anterior, the strongest, wide and short has a sensory pore, close to the one in the nasal; the median posterior, long, straight and pointed, and the posterolateral, that connects with the second infraorbital, has also a sensory pore.

The lacrymal articulates through ligaments to the premaxilla, maxilla, palatine, and ethmoid.

**Synonymy**      Lat. os lacrimale                  Fr. Lachrymal

lacrimal, lacrymal, lachrymal    Most authors

adnasal                                  McMurrich (1884)

preorbital                                Berg (1940)

antorbital                                Sagemehl (1883); Gauba (1966); Arratia and Huaquín (1995)

## II.3 SPLANCHNOCRANIUM

#### Definition and Description

The splanchnocranium is the assemblage of bones of chondral or dermal origin related to respiration and feeding. Its four main units are: the suspensorium, mandibular arch (upper and lower mandibles), hyoid arch, and branchial arches.

## C.1 SUSPENSORIUM

### Definition and Description

The suspensorium is the assemblage of bones that links the upper mandible to the skull in gnathostome fishes. It has the shape of a wide V, with its anterior arm abutting against the ethmoidal region and the posterior connecting to the pterotic and occipital regions of the skull.

The anterior arm develops at the expense of the cartilaginous quadrate bar, which in siluroids divides into two sections: the *pars palatina* and the *pars pterigoquadrata* (Arratia and Schultze 1991). The former ossifies into the palatine bone, while the latter changes into the ectopterygoid, endopterygoid, metapterygoid, and quadrate bones. The arms join at the posterior end of the maxilla where the dentary, acting as a pivot for both arms, joins the lower mandible in a ball-and-socket articulation.

In *A. nebulosus*, as in all Ictaluridae, the suspensorium presents several modifications. The palatine is displaced and does not participate in the supporting function of the suspensorium, since it does not join the pterygoid series. Instead, it acts as support for the maxillary barbel. Also, one of the first two pterygoids and the symplectic are missing.

The preopercular bone joins posteriorly the hyomandibular and quadrate to support the suspensorium in its lateral movement during swallowing and breathing. Although the preopercular is not formed from the hyoid arch, from a functional point of view it can be included in the suspensorium apparatus.

The dermal bones, premaxilla and maxilla, joined the anterior arm during the evolutionary process, reinforcing in this way, the core of the upper mandible.

**Synonymy**      Lat. suspensorium      Fr. suspenseur

### C.1a PALATINE

#### Definition and Description

The palatine is a paired bone of endochondral origin, formed at the anterior end of the palatoquadrate bar (Fig. 16A). In Ictaluridae, the palatine has lost its connection with the rest of the suspensorium and functionally has been associated with the maxillary barbels (Alexander 1965).

Its well-ossified anterior end articulates with the lacrymal, and, through its anterior circular condyle, with both the premaxilla and maxilla. The shaft of the bone is slender, ending in a spatulate or lanceolate tip. Its medial side shows an ellipsoidal facet, the result of its articulation with the lateral ethmoid.

|                 |   |             |
|-----------------|---|-------------|
| <b>Synonymy</b> | Lat. os palatinum   | Fr. Palatin |
| palatine        | McMurrich (1884); Kindred (1919); Alexander (1965); Grande and Lundberg (1988); Grizzle and Rogers (1976); Fink and Fink (1981); Baumgartner (1982); Diogo, Oliveira and Chardon (2000) |             |
| autopalatine    | Tilak (1963); Gosline (1975); Arratia (1992) states that “catfishes do not have a dermopalatine so the bone should be called autopalatine.”   |             |

### C.1b ECTOPTERYGOID

#### Definition and Description

The ectopterygoid is a laminar chondral bone located on the anterolateral edge of pterygoid series (ectopterygoid, endopterygoid, and metapterygoid).

In *A. nebulosus*, it has a subquadrangular shape of appreciable size with its surface crossed by thin ridges (Fig. 16B). Its status has not been yet elucidated for catfishes, but Kindred (1919) specifically states that it is present in *Amiurus nebulosus catus*. Lundberg (1982), on the contrary, clearly says that “the ectopterygoid is absent in all ictalurids.” Alexander (1965) referring to Siluroidei, says that “the ectopterygoid is small (*Diplomystes*, etc.) or absent”. Since Ictaluridae are so closely related to Diplomystidae, I am inclined to consider it to be present in *A. nebulosus*, since in the specimens examined, this bone fits in a small curvature on the outer section of the anterior border, although in a few specimens is located in a more central position.

|                 |  |                    |
|-----------------|--|--------------------|
| <b>Synonymy</b> | Lat. os ectopterygoideum   | Fr. ectoptérygoïde |
| ectopterygoid   | McMurrich (1884) calls it in the text <i>bone number 4</i> , but in the drawings, ectopterygoid; Kindred (1919); Alexander (1965); Tilak (1963). |                    |
| pterygoid       | Gregory (1933); Grizzle and Rogers (1976)  |                    |
| exopterygoid    |  |                    |

#### Iconography

Lundberg, J. G. 1982. Fig. 21

### C.1c METAPTERYGOID

#### Definition and Description

The metapterygoid is a paired chondral bone formed from the palatoquadrate bar (Fig. 16B). Its anterior margin has a concave shape for the attachment of the ectopterygoid. The lower margin is smooth and slightly concave. The dorsal margin is partially smooth and partially dentated. The posterior margin joins suturally the hyomandibular and the quadrate.

**Synonymy**      Lat. os metapterygoideum      Fr. Métaptérygoïde

metapterygoid                      McMurrich (1884) in the text, but in the drawing he labelled it, pterygoid.

pterygoid and metapterygoid      Grizzle and Rogers (1976)

#### Iconography

Lundberg (1992)                      Fig. 2b

### C.1d HYOMANDIBULAR

#### Definition and Description

The hyomandibular is a paired chondral bone formed by the ossification of the dorsal section of the hyoid arch. It is a strong bone, able to resist the pressure of the suspensorium in its laterad movement (Fig. 17).

The hyomandibular fits into and articulates with a long groove, called the hyomandibular fossa, excavated into pterosphenoid and pterotic bones. The dorsal margin of the hyomandibular is divided into two processes: the anterior, which articulates with the pterosphenoid; and the posterior, larger and arched, which connects the sphenotic and pterotic bones. Both processes fit into the hyomandibular fossa through synchondral sutures.

The anterior margin of the hyomandibular is laminar and forms, at its upper half, a deep concavity, while the lower half is convex and presents many indentations. The lower margin of the bone is strong and articulates suturally with the metapterygoid and synchondrally with the quadrate. The posterior margin presents dorsally a narrow process for the attachment of the *levator operculi* muscle, and below it, there is a large protuberance, the *processus opercularis*, that fits into a cavity of the opercular bone. Ventrally, a large process, partially hollow, meets the preopercle.



On the lateral face, there are two strong crests, one horizontal - the *levator* crest which serves as attachment for the *levator palatini* muscle, and a second oblique and curved, the adductor crest, which serves as the origin for the A3 branch of the *adductor mandibularis* muscle. On its mesial face there is a foramen for the passage of the hyomandibular branch of the facial nerve.

In most catfishes, the hyomandibular bone abuts against the neurocranium as the only connection for the suspensorium.

**Synonymy**    Lat. os hyomandibulare    Fr. hyomandibulaire

**Osteometry**    Fig. 17D and Table 13

- AB**    Height. Minimum distance between the most posterior point of the dorsal margin and the most ventral point of the bone.
- AC**    Dorsal margin length. Minimum distance between the most anterior point and the most posterior point of the dorsal margin.
- CD**    Width. Distance between the most anterior point of the anterior process and the outermost point of the opercular knob.

#### **Cross references**

Thomas (pers. comm.) calls *sphenotic - opercular length* our width.

### **C.1e QUADRATE**

#### **Definition and Description**

The quadrate is a paired chondral bone resulting from the ossification of the posteroventral section - the *pars quadrata* - of the palatoquadrate bar. The quadrate is located at the base of the posterior arm of the suspensorium for which it acts as a pivot (Figs. 18 A, B and C). It is a strong bone and, as its name implies, has a quadrangular shape. Its dorsal margin articulates synchondrally with the hyomandibular but there are some indentations with which it also joins the metapterygoid; the anterior margin meets the metapterygoid through a suture; the ventral and posterior margins are strong and free. The ventral angle of the bone presents a strong saddle-like articular facet that hinges with the angular (= articular of authors) condyle. In *A. nebulosus*, the quadrate has a small process called the posteroventral or quadratojugal process. This process, present in many groups of bony fishes, could represent, according to Patterson (1975), the quadratojugal of primitive actinopterygians. The preopercle occupies the area left free between the body of the quadrate and the quadratojugal process.

The outer facet of the quadrate presents several convergent grooves and ridges, while the mesial side is smooth and slightly concave.

**Synonymy**      Lat. os quadratum                      Fr. carré  
quadratojugal process      Patterson (1975)  
posteroventral process      Arratia and Schultze (1991)

**Osteometry**      Fig. 18B and Table 14

**AB**      Height. Minimum distance between the most dorsal and most ventral points.  
**CD**      Width. Minimum distance between the most anterior and the most posterior points.

### C.1f PREOPERCLE

#### Definition and Description.

The preopercle is a narrow, strong, membrane bone located posterior to the suspensorium, which it reinforces by preventing it from sliding outwards (Fig. 18D). In spite of its name, the preopercle of Ictaluridae belongs more to the suspensorium complex than to the opercular series. The preopercle is an elongated bone whose anterior margin almost ankyloses with the hyomandibular and the quadrate. In the middle of the anterior margin, the bone expands into two laminae that embrace the ventral part of the hyomandibular and the upper part of the quadrate. The mandibular branch of the sensory canal runs along the posterior border of the preopercle, where several pores open.

The preopercle posterior margin is convex; its upper pointed section bends forward and it is partially covered by the dorsal suprapreopercle and partially by the hyomandibular articular condyle. The preopercle anterior ventral section fits into the space left between the quadrate and its quadratojugal process; its posterior ventral section embraces the quadratojugal process.

**Synonymy**      Lat. os præoperculum                      Fr. Préoperculaire  
preopercular  
preopercule  
interopercular                      Parker (1874); Regan (1911)  
præoperculare (os)                      Lepiksaar (1981-1983) Manuscript

**Osteometry**      Fig. 18D and Table 15

**AB**      Height. Distance between the most dorsal and most ventral points.

## II. C.2 UPPER MANDIBLE

### C.2a PREMAXILLA

#### Definition and Description

The premaxilla of *A. nebulosus* is a small paired dermal bone located at the anterior end of the upper jaw (Fig. 19A). It is rectangular in shape and wider than the maxilla, and lacks the characteristic ascending process present in many teleostean fishes. Its dorsal surface presents several pits and foramina. The premaxilla ends in a triangular depression with a small caudal process at its most distal point. A dental plate with five to six rows of teeth at the symphysis, but reduced to two or three rows at its distal end, covers its ventral face. The teeth are long, thin, sharp, and curved backwards. Two specimens (#1 and #2) from unspecified location in Hants Co. (Nova Scotia) have only one or two rows of teeth in the premaxillae.

The premaxilla meets its antimere in a symphyseal articulation. It articulates with the ethmoid at its dorsal surface and connects with the palatine and the maxilla by several short ligaments.

**Synonymy**      Lat. os præmaxillare      Fr. Prémaxillaire  
premaxillary  
intermaxillary  
surmaxillary  
bimaxillary

### C.2 b MAXILLA

#### Definition and Description

The maxilla is a paired dermal bone attached to the premaxilla by ligaments and two bony processes: one thick in a dorsal position and another, ventral, ending into a small hook (Fig. 19C). In *A. nebulosus*, the maxilla is a slender cylindrical bone that grows outward, losing its alignment with the gape of the mouth, contrary to the position typical in most teleosts. It has lost the teeth and, consequently, its function has changed from feeding to supporting the maxillary barbel. It also articulates with the palatine and the lacrymal via its anterior condyles.

**Synonymy**      Lat. os maxillare      Fr. Maxillaire  
maxillary

## II.C.3 LOWER MANDIBLE

### C.3a DENTARY

#### Definition and Description.

The dentary is a paired, mostly dermal bone that forms the anterior part of the lower mandible (Fig. 20). Both McMurrich (1884) and Kindred (1919) agree that the dentary is of mixed origin, being formed partially from Meckel's cartilage, which still remains in the form of a cartilaginous rod. The dentary has a triangular shape, being narrow anteriorly and wider at its caudal end, where it splits into two laminae that leave a narrow space between them, a remnant of the Meckelian cavity occupied by the angular. The posterior margin presents two long processes: the coronoid, dorsally, and a longer ventral caudal process.

Close to the ventral margin runs the mandibular branch of the lateral line canal with five or six sensory pores. Above the lateral line canal, the mental foramen opens allowing the passage of the mandibular branch of the trigeminal nerve.

A dental plate packed with conical and backward curved teeth arranged in five or six rows at its anterior occupies about two thirds of the dorsal margin. The number of rows of teeth tapers to a row or two at the posterior end of the bone. Two specimens (#1 and #2) from unspecified location in Hants Co. (Nova Scotia) have only one or two rows of teeth in the dentaries.

The dentary joins synchondrally with its antimere at the mental symphysis and posteriorly meets the angular.

**Synonymy**      Lat. os dentale                      Fr. Dentaire

dentalo-splénial-mentomandibular

Holmgren and Stensiö (1936); Pehrson (1944);  
Lekander (1949)

dento-splénial                      Holmgren and Stensiö (1936); Jollie (1986)

dentale (os)                      Lepiksaar (1981-1983) Manuscript.

**Osteometry** Fig. 20D and Table 16

**AB**      Dorsal margin length. Minimum distance from the anterior margin of the mental symphysis to the most posterior point on the coronoid process.

**AC**      Ventral length. Distance from the anterior margin of the mental symphysis to the most posterior point of the caudal process.

**CD**      Height. Distance between the most dorsal point of the coronoid process to the most ventral point of the caudal process.

## Cross references

Thomas (personal comm.) calls “*length of body*” our total dorsal margin length.

## Iconography

Lundberg (1982) Fig. 21E

## C.3b ANGULAR

### Definition and Description

The angular, often called articular, is a paired bone of endochondral and membranous origin that forms the posterior part of the lower mandible (Fig. 21). In *A. nebulosus*, it has a triangular shape. Its anterior margin articulates with the dentary, fitting into a narrow chamber, a remnant of the Meckelian cavity. On its inner face there is a cavity from which the Meckel’s cartilage (Fig. 21D) arises and extends into the dentary. Its dorsal vertex extends upwards and backwards, forming the coronoid process. Its thick posterior vertex forms a socket for the articulation with the quadrate. This vertex is reinforced ventrally by the retroarticular, a small bone whose features can be recognized even after its fusion with the angular. On its mesial face, the angular supports the small coronomeckelian.

Haines (1937) and Lekander (1949) proposed the term angular, since its predominantly membranous part is homologous to the true angular. See also Weitzmann (1962).

| <b>Synonymy</b>                  | Lat. os angulare | Fr. Angulaire   |
|----------------------------------|------------------|---|
| angular                          |                  | Haines (1937); Lekander (1949)  |
| articular                        |                  | McMurrich (1884); Kindred (1919); Gregory (1933); de Beer (1937); Berg (1940); Grizzle and Roger (1976) |
| angulo-articulo-retroarticular   |                  | Nelson (1969)   |
| angulo-articular                 |                  | Nelson (1969) when the retroarticular is present; Grande and Lundberg (1988)                            |
| angular+articular+retroarticular |                  | (Arratia (2003a)  |
| articulare (os)                  |                  | Lepiksaar (1981-1983)   |
| dermarticular                    |                  | Goodrich (1930)   |

**Osteometry** Fig. 21C and Table 17

- AB** Length. Minimum distance in a straight line from the most anterior point of the bone to its most posterior point.
- AC.** Length of the anterior margin. Minimum distance in a straight line between the most anterior point of the bone and the most dorsal point of the coronoid process.
- CD.** Height. Distance from the most dorsal point of the coronoid process to the point directly below on the lower margin.

### C.3c RETROARTICULAR

#### Definition and Description.

The retroarticular is a small endochondral paired bone that forms the posterior part of the lower mandible (Fig. 21A). It was called angular, on account of its position in the mandible, but Böker (1913) proposed the new term retroarticular. In *A. nebulosus*, it fuses completely with the angular, although it still can be detected by its triangular shape and its pointed anterior process, features it shares with those of many other fish groups. It was not mentioned by Kindred (1919) in his description of the skull development in *A. catus*, but McMurrich did.

|                 |   |
|-----------------|---|
| <b>Synonymy</b> | Lat. os retroarticulare Fr. articulaire |
| retroarticular  | Böker (1913)                            |
| angular         | Gregory (1933); Alexander (1965)        |
| angulare        | McMurrich (1884)                        |
| “a” ossicle     | Bridge (1877)                           |

### C.3d CORONOMECKELIAN

#### Definition and Description

The coronomeckelian is a chondral bone formed from Meckel’s cartilage at its most posterior section. It is a delicate small bone of irregular shape sometimes fused to the mesial facet of the angular (Fig. 21D).

Meckel’s cartilage forms the core of the lower mandible, homologous to the palatoquadrate bar of the upper mandible. It is present in Ictaluridae and in most modern fishes as a thin cartilaginous cylinder originating at the inner facet

of the articular. It tapers along the dentary and ends close to the mental symphysis.

Neither McMurrich (1884) nor Kindred (1919), both of which described the skull in great detail, mentioned this bone which is clearly visible in all of our specimens.

|                        |                             |                     |
|------------------------|-----------------------------|---------------------|
| <b>Synonymy</b>        | Lat. os coronomeckelium     | Fr. coronomeckélien |
| splénial               | Owen, (1848); Nawar (1954)  |                     |
| os Meckeli             | Berg (1940)                 |                     |
| supraangular           | Holmgren and Stensiö (1936) |                     |
| “d” bone (“d” ossicle) | Bridge (1877)               |                     |
| articular sesamoid     | Ridewood (1904)             |                     |

## II.C.4 HYOID ARCH

### Definition and Description

The hyoid arch is the second arch after the mandibular, excluding from the count the hypothetical premandibular arch. The most accepted interpretation is that the dorsal branch of this arch is made up of the hyomandibular, the symplectic, and the interhyal, while the ventral branch is formed by one or two hypohyals, the ceratohyal, and the epihyal. The symplectic is absent in *A. nebulosus*.

|                 |                     |                  |
|-----------------|---------------------|------------------|
| <b>Synonymy</b> | Lat. arcus hyoideus | Fr. arc hyoïdien |
|-----------------|---------------------|------------------|

**Osteometry** Fig. 22B and Table 18

**AB** Length. Minimum distance between the most anterior and the most posterior points.

## C.4a HYPOHYALS

### Definition and Description

The pyramid-shaped hypohyals form a pair of endochondral bones located at the anterior end of the *hyoid arch*. They are named according to their relative position in the *hyoid arch*, the dorsal and the much larger ventral. Both hypohyals articulate with each other and also with their corresponding ceratohyal by chondral joints. The ventral hypohyals meet anteriorly in a symphyseal joint, and articulate through ligaments with the urohyal (Fig. 22A and 22B).

Kindred (1884) mentions only one hypohyal “usually connected with one or two accessory nodular bones.”

**Synonymy**      Lat. os hypohyale    Fr. hypohyal

dorsal hypohyal + ventral hypohyal

Kusaka (1974) and most authors

first hypohyal + second hypohyal

Srinivasachar (1958)

upper hypohyal + lower hypohyal

McAllister (1968)

dorsohyal + ventrohyal    Nelson (1969)

(For a more complete discussion of the homologies of the hyoid arch elements, see Nelson (1969). The synonyms given for the hypohyals, ceratohyal, and epihyal have been taken from Rojo (1988, 1991) and Arratia and Schultze (1990)).

## C.4b CERATOHYAL

### Definition and Description

The ceratohyal is the largest paired chondral bone of the hyoid arch. In *Ameiurus nebulosus*, this bone articulates anteriorly with the hypohyals and its posterior end meets synchondrally the epihyal. This connection is reinforced with a wide band of laminar bone with interdigitating spicules (Figs. 22A and 22B).

Holmgren and Stensiö (1960) consider the ceratohyal and the epihyal in teleostean embryos as two ossification centers of the same bone. According to this interpretation, the anterior, ventral or proximal ossification was given the



name of ventral ceratohyal (commonly known as ceratohyal) and the posterior, dorsal or distal ossification was named dorsal ceratohyal, better known as epihyal.

| <b>Synonyms</b>     | Lat. os ceratohyale            | Fr. cératohyal |
|---------------------|--------------------------------|----------------|
| ceratohyal          | McMurrich(1884)                | Most authors   |
| ceratohyal I        | Nielsen (1942)                 |                |
| anterior ceratohyal | Jollie (1962); Arratia (2003a) |                |
| anterohyal          | Nelson (1969); Howes (1983)    |                |
| distal ceratohyal   | Schaeffer and Patterson (1984) |                |
| keratohyale         | Lepiksaar (1981-1983)          |                |

**Osteometry** Fig. 22B and Table 19

- CD** Posterior margin height. Maximum distance between its most extreme points.
- DE** Ventral margin length. Maximum distance between its most anterior and its most posterior points.

**C.4c EPIHYAL**

**Definition and Description**

The epihyal is a paired endochondral bone located at the end of the hyoid arch. In *A. nebulosus*, it has a triangular shape. Its large anterior border articulates synchondrally with the ceratohyal and, at its pointed dorsal end, with the small interhyal. Its ventral border supports the last two large branchiostegal rays (Figs. 22A and 22B).

| <b>Synonymy</b>      | Lat. os epihyale               | Fr. épihyal  |
|----------------------|--------------------------------|--------------|
| epihyal              | McMurrich (1884)               | Most authors |
| ceratohyal II        | Nielsen (1942)                 |              |
| dorsal ceratohyal    | Holmgren and Stensiö (1960)    |              |
| posterior ceratohyal | Jollie (1962); Arratia (2003a) |              |
| posterohyal          | Nelson (1969); Howes (1983)    |              |
| proximal ceratohyal  | Schaeffer and Patterson (1984) |              |

#### C.4d INTERHYAL

##### Definition and Description

The interhyal is a small endochondral bone that links the hyoid arch with the suspensorium through the symplectic bone. In *A. nebulosus*, the interhyal is a small, almost vestigial bone of triangular shape that articulates with the epihyal with its dorsal tip resting freely on the quadrate and preopercle (Fig. 22A).

Kindred (1919) does not mention this bone. Lundberg (1982) named it only for *Trogloglanis*, and Arratia (2003a) for *Diplomystes*, with no reference to other Ictaluridae. Grizzle and Rogers (1976) named and illustrated it for *I. punctatus*.

The term stylohyal used for tetrapods should be discarded for fishes, since both bones are not homologous, according to Norman (1926).

**Synonymy**      Lat. os interhyale      Fr. interhyal

stylohyal      Sewerstofft (1928)

stylohyale      Lepiksaar (1981-1983)

#### C.4e UROHYAL

##### Definition and Description

The urohyal is a medial bone formed in actinopterygians from the ossification of the tendons of the two sternohyoid muscles (Ridewood, 1904) (Figs. 22C, 22D, 22E). According to Arratia and Schultze (1990), the urohyal of siluroids develops from a double ossification of the tendons, for which they propose the new name *parurohyal*. The urohyal lies at the junction of the two branches of the hyoid arch, between the hypohyals. In *A. nebulosus*, the urohyal consists of a ventral triangular lamina, narrow in front and wide at the back, with a large oval foramen, the hypobranchial foramen, for the passage of the hypobranchial artery. On its dorsal surface there is a vertical crest that overlaps the posterior margin of the triangular lamina. The hypobranchial foramen continues backwards and splits into two openings on each side of the crest. Anteriorly, this crest splits into two membranes in a Y shape forming a cup-like structure.

The urohyal articulates by way of a ligament with each of the two ventral hypohyals.

|                 |                                      |             |
|-----------------|--------------------------------------|-------------|
| <b>Synonymy</b> | Lat. os urohiale                     | Fr. urohyal |
| urohyal         | Owen (1848) and most authors         |             |
| parahyoid       | de Beer (1937); Srinivasachar (1958) |             |
| parahyal        | de la Hoz y Arenas (1976)            |             |
| parurohyal      | Arratia and Schultze (1990)          |             |

**Osteometry** Fig. 22D and Table 20

- AB** Length. Maximum distance between the anteriormost and the posteriormost points.
- CD** Anterior width. Distance between the two most extreme points of its anterior margin.
- EF** Posterior width. Distance between the most extreme points of the alar expansions.

**Iconography**

Lundberg (1982) Fig. 30.

## II.C.5 BRANCHIAL APPARATUS

### Definition and Description

The branchial apparatus, also called, branchiocranium, is a well defined assemblage of endochondral and dermal bones related directly or indirectly to feeding and respiration. Its endochondral bones can be grouped into two series: the middle or basibranchial series, and the lateral or branchial series, consisting of five pairs of arches, each one made up of four bones: the hypobranchial at the base, followed upward by the ceratobranchial, the epibranchial, and, uppermost, the pharyngobranchial. The first two are directed backwards making up the lower half of the arch, while the latter two are bent forward and form the upper part of the arch (Fig. 23). The dermal elements are represented by gill rakers, arranged serially on the edges of the arches, and by dentigerous plates.

The evolution of the branchial arches has followed two main trends: the disappearance of dental plates in the anterior arches and the reduction of chondral elements in the posterior ones. The branchial apparatus of *A. nebulosus* reflects these two tendencies.

**Synonymy**      Lat. arcus branchiales      Fr. arcs banchiaux

(For a historical account of the terminology of the bones of the branchial apparatus see Nelson (1968, 1969)).

### **Iconography**

McMurrich (1884) for *Amiurus catus*

Lundberg (1982)      Fig. 30B

## **C.5a BASIBRANCHIALS**

### **Definition and Description**

The basibranchial bones constitute a series of middle endochondral, small bones, reduced in *A. nebulosus* to two basibranchials, BB1 and BB2 (Fig. 23).

**Synonymy**      Lat: ossa basibranchialia      Fr. os brasibranchiaux  
copula      McMurrich (1884)

## **C.5b HYPOBRANCHIALS**

### **Definition and Description**

In *A. nebulosus*, only the first and second hypobranchials are ossified as laminar bones. They articulate laterally with their respective ceratobranchials and medially with the first and second basibranchials (Fig. 23).

### C.5c CERATOBANCHIALS

#### Definition and Description

The ceratobranchials are the longest bones of the series and all five are well ossified (Fig. 23). The first and second ceratobranchials articulate ventrally with the first and second hypobranchials. The fifth ceratobranchial has an oval dental plate attached, to which small, but conspicuous teeth were added. This complex structure was named hypopharyngeal by McMurrich (1884), following previous authors. Jollie (1962) and many modern authors use the term suprpharygobranchial (Van Wijhe, 1882) for the complex structure, referred here as CBV + DPV + T. Ceratobranchials I-IV carry two rows of gill rakers, but CV only the lateral row.

The posterior faces of the first four ceratobranchials are deeply grooved for the attachment of the branchiae.

### C.5d EPIBRANCHIALS

#### Definition and Description

Only epibranchials I-IV are present (Fig. 23). Epibranchials one and two have two rows of gill rakers, the third has only one row and the fourth lacks them. EBIII articulates with PHBIII-IV and its dorsolateral border extends into a process that rests on EBIV, which in turn has its dorsal border expanded into a large knob. The dorsal sides of the first two epibranchials are also deeply grooved.

### C.5e PHARYNGOBRANCHIALS

#### Definition and Description

There are only two pharyngobranchials in brown bullhead (Fig. 23) which, McMurrich consider them to be the second and third in *Amiurus catus*. Lundberg (1982) refers to them as the 3rd and 4th for *Trogloglanis*, an interpretation which is also applicable to *A. nebulosus*, due to their relative position.

## C.5f DENTAL PLATES

### Definition and Description

Most dental plates have disappeared in *A. nebulosus* (Fig. 23), but two sets have remained. One, well developed, oval in shape, with numerous small teeth, is attached to the ventral face of the fifth ceratobranchials. Another, equally strong overlaps the ventral surfaces of PHBIII, EBIII and EBIV, is also packed with teeth. Both plates are coordinated in their function of retaining the prey.

The second plate breaks easily into three units, implying that three dental plates (DPII, DPIII, and, probably DPIV) contributed to its formation. This dental plate with teeth was named epipharyngeal by McMurrich (1884) following previous authors. Lundberg (1982) and Arratia (2003a) use the term “infrapharyngobranchials” to refer to any of the pharyngobranchials, with or without dental plates. For a more detailed synonymy, see Nelson (1969).

## C.5g GILL RAKERS

Previous studies (see Lundberg 1982) give a total count of 11 gill rakers for the first branchial arch of *Ictalurus*, with all rudiments included. The number, in a sample of 19 specimens of *A. nebulosus* in our study, ranges from 12 to 15, not including rudiments (Fig. 23 and Tables 30 and 31).

## II.D. VERTEBRAL COLUMN

### Definition and Description

The vertebral column of *A. nebulosus*, like that of all ostariophysian fishes, can be divided into three well-defined units. The first five vertebrae, highly modified into a complex functional unit, form the Weberian apparatus (See this term and Figs. 24 and 25). The second unit consists of the precaudal (= thoracic or abdominal) vertebrae characterized by having well-developed neural arches. Due to the interference of the dorsal pterygiophores, the first five vertebrae do not have neural spines. Their neural arches have bifid ends that embrace the pterygiophores. All vertebrae in this group have lateral parapophyses to which ribs are attached (Fig. 26 A and B).

The vertebrae of the third unit, the caudal vertebrae, have well-developed neural and hemal arches and, fused to them, neural and hemal spines, respectively (Fig. 26C).

Two dorsal pairs of small zygapophyses, one anterior (prezygapophyses) and the other posterior (postzygapophyses) link consecutive vertebrae. On the ventral side of the each vertebra, there are small expansions similar in shape and function (Fig. 26 C and 27).

The number of the precaudal and caudal sections varies with individual fish and population. In our sample of 28 specimens, the number of precaudals varies from 7 to 11. The caudals range from 22 to 29, making a total variation of between 31 and 38 vertebrae. Including the five vertebrae from the Weberian apparatus, the total number of vertebrae increases to 36 and 43 (Tables 30 and 31).

The number and distribution of the vertebrae has been used as a discriminatory tool to separate sibling species and fish populations. Lundberg (1982) gives a table with the distribution of the vertebrae for several Ictaluridae, but unfortunately, *nebulosus* is missing. He includes in his count the five vertebrae of the Weberian complex.

Appelget and Smith (1951) used vertebrae to estimate the age of *Ameiurus lacustris punctatus* and Lewis (1949) for *Ameiurus melas melas*.

For a detailed description of the tail section of the vertebral column, see Caudal Skeleton.

### Synonymy

Lat. columna vertebralis

Fr. colonne vertébrale

## D.1 WEBERIAN APPARATUS

### Definition and Description

The Weberian apparatus is a complex osteological unit, which conjointly with the gas bladder is engaged in the hearing of ostariophysan fishes. Weber (1820) studied a series of small bones in Cyprinoid fishes, which he considered homologous with the human ear ossicles and accordingly, named them claustrum, stapes, incus, and malleus. Bridge and Haddon (1889) demonstrated that these bones, originating from various vertebral elements, are not homologous with the auditory ossicles of mammals. These authors proposed the name Weberian ossicles for the whole series and new names for individual bones: the stapes became scaphium, the incus, intercalarium, and the malleus, tripus. They retained the name claustrum. This nomenclature has been widely admitted, except in some Northern and Eastern European countries, which continue to use the Weberian nomenclature.

The Weberian apparatus of *A. nebulosus* consists of the following four parts (Fig. 24).

1. The auditory unit, *pars auditum*, is made up of four paired bones whose ontogenetic origin is still a matter of discussion among embryologists.

The claustrum (Fig. 25A), the most anterior Weberian ossicle, is a laminar bone of quadrangular shape that connects with the exoccipital and the scaphium.

The scaphium (Fig. 25 B) has an ascending process, an anterior horizontal concave expansion called *concha*, that roughly takes the shape of a skiff, from which it gets its name, and a small globular body, the *processus articularis*, which attaches to a small facet on the first vertebra. This bone also connects with the exoccipital, the basioccipital and, through the *ligamentum scaphii*, with the intercalarium.

The intercalarium (Fig. 25C) is a small, elongated bone of triangular shape with its base in an anterior position. It attaches by two small ligaments, the *ligamentum scaphii* and the *ligamentum tripodis*, to the anterior processes of the scaphium and tripus, respectively. Smith (1956) described the intercalarium of *A. nebulosus* as "a short [bone] that sometimes reaches the body of the complex centrum." In our specimens, the intercalarium never reaches the complex centrum.

The tripus (Fig. 25C) is a long flat bone with three processes from which it derives its name. Its smooth anterior process extends from the first vertebra to the compound centrum. A median process attaches to the complex centrum and a posterior process fuses with a curved body, called the transformator process or *transformator tripodis*. This last process frequently detaches in the preparation process.

The claustrum and scaphium are set in a vertical plane, while the intercalarium and the anterior part of the tripus are horizontally set.



2. The supporting unit, *pars sustentaculum*, consists of two elements. The first one is a slender bone, *os suspensor*, that at its upper end fuses with the compound vertebra and grows down and forward to reach the second vertebra where it ends in a free tip. Because of its orientation, McMurrich called it oblique bone.

The second element consists of two long, large sheets of bone, sometimes called together *ossa suspensoria*, that extend downward on each side the entire vertebral complex. Ventrally, they protect the dorsal aorta that runs along the aortal canal (Fig. 24B)

3. The compound vertebra is the result of the fusion of a variable number of vertebrae. According to McMurrich (1884), there are only four vertebrae in *Amiurus catus*, since the second vertebra has “completely disappeared and fused to the third.” According to Wright (1884), the first vertebra of *Amiurus* combines with the second, third and fourth vertebrae to which the fifth later joins. Bridge and Haddon (1889) state that in *Amiurus* “the second centrum is indistinguishably combined with the third and fourth.” They further add that, “the complex is attended by the partial ankylosis of the latter to the fifth vertebra.” Kindred (1919) and Yerger and Relyea (1968) consider four vertebrae, the fused second, third, and fourth, plus the posteriorly attached fifth.

The compound vertebra in our sample of 24 specimens has five vertebrae: the first, the second, and the fifth are clearly identifiable, while the third and fourth are completely fused with no visible sign of their union (Fig.24B).

The interpretation of some authors (Sagemehl, 1891; Fürbringer, 1897; Kindred, 1919; de Beer, 1937, and Yerger and Relyea, 1968) that the first vertebra is the one joined in ontogeny to the basioccipital is rejected here as a moot issue, since it has lost both its individuality and its function.

The vertebra considered here the first vertebra in the compound complex has its anterior face articulating via a diarthrosis with the basioccipital. Its posterior face fuses to the second vertebra at its ventral section, but is free for more than half of its upper section. In fact, the connection with the second is so weak that often the vertebra separates completely from the complex. On its dorsal face there are two pits for the attachment of the articular processes of each scaphium.

The second vertebra, also clearly visible, fuses at its base with the long segment made up by the third and fourth, but its upper section still shows the suture with the complex vertebra and a large part of its centrum clearly visible. The third and fourth vertebral centra ankylose into a long centrum.

The connection between the fourth and the fifth is variable and gradual (Fig. 24B). A suture line can be seen at the level of the neural arch while at the level of the centra there is evidence of different degrees of fusion. A sample of 13 specimens shows complete fusion in eight, while five specimens still show a narrow opening. Even in the absence of an opening, interdigitating strands of bony tissue are present at the same level of the openings, implying that this area is the connection between the fourth and fifth vertebrae. This feature is

clearly visible in three large specimens caught in Lake Erie, Lake St. Claire, and Lake Ontario on loan, courtesy of the Royal Ontario Museum (Toronto, Canada). No vital statistics were available for these specimens.

4. The neural complex results from the modifications of the neural arches and parapophyses of the first five vertebrae. The first, second, and third vertebrae lack their neural arches, neural spines, parapophyses, and hemal arches.

The first neural arch which is present relates to the fourth vertebra (Chardon et al. 2003) and grows forward, ending in a neural bifid spine that does not reach the laminar extension of the supraoccipital spine. The posterior bifid neural spine extends downwards into a lamina that embraces the first and second pterygiophores of the dorsal fin.

The parapophyses of the fourth vertebra expand laterally into an ample lamina with three pairs of lateral processes: the Müllerian ramus or anterior part of the transverse process that extends forward and bends downward to join the posttemporal; the posterior part of the transverse process, thick and blunt; and the much smaller posterior process that reaches the transverse process of the fifth vertebra (Fig. 24A).

The neural arch of the fifth vertebra is bifid, lacks its neural spine, and its horizontal parapophyses are curved forward.

Grande and Shardo (2002) state that the first rib in *I. punctatus* belongs to the fifth vertebra. In *A. nebulosus*, the first rib belongs clearly to the sixth vertebra.

**Synonymy**      Lat. apparatus weberianus    Fr. appareil de Weber

|                                   |   |
|-----------------------------------|---|
| Weberian ossicles                 | auditory ossicles Weber (1820)  |
| scaphium                          | stapes Weber (1820)   |
| intercalarium                     | incus Weber (1820)  |
| tripus                            | malleus Weber (1820)  |
| transformator process             | Chardon et al. (2003)   |
| transformator tripodis            | Chardon et al. (2003)   |
| crescentic process                | McMurrich (1884); Smith (1956)  |
| anterior process (scaphium)       | concha scaphii  |
| complex vertebra                  | Bridge and Haddon (1889)  |
| compound vertebra                 | Kindred (1919)  |
| Müllerian ramus                   | Described by Müller (1842)  |
| anterior part of 4th parapophysis | Grande and Shardo (2002)  |
| transverse processes              | Wright (1884); Tavalga (1962); Baumgartner (4th vert.) (1982); Grande and Shardo (2002) |
| parapophysis                      | Arratia (2003b)   |

basapophysis

suspensor bone(s), *os suspensorium* (pl. *ossa suspensoria*)

**Osteometry** Figs. 24A and 24B and Table 21

- AB** Length. Distance between the anterior margin of the first vertebra and the posterior margin of the fifth.
- CD** Width. Distance between the two most lateral points of the Müllerian processes.
- EF** Height. The distance between the tip of the neural arch of the fourth vertebra and the base of the complex vertebra.

**Iconography**

- Smith (1956) Plate XI. The intercalarium represented for *A. nebulosus* differs in shape from those in our sample and her tripus has different orientation.
- Chardon et al. (2003) Figs 3.4 to 3.7.

## D.2 CAUDAL SKELETON

### Definition and Description

The caudal skeleton consists of the bones that support the musculature and fin rays of the fish tail, i.e., the vertebrae, their neural and hemal arches, and the structures derived from them. The caudal skeleton proper consists of three series of bony elements: *epaxial*, those derived from the neural arches and spines; *axial*, the vertebral centra and elements derived from them, and *hypaxial*, those located below the vertebral axis and derived from the hemal arches (Fig. 26).

The epaxial series in *A. nebulosus*, consists of the neural arches of the preural vertebrae that support the principal caudal fin rays. McMurrich (1884) considers PU<sub>6</sub> as the first vertebra supporting rays in *Ameiurus catus*, but in our sample the first supporting vertebrae varies up to PU<sub>8</sub>. Also included in this series is a free epural that almost rests on a bony knob of PU<sub>2</sub>. The epural looks like a detached neural spine, an interpretation already noted by Schultze and Arratia (1989).

The axial series consists of the modified last three centra: the first preural (PU<sub>1</sub>), the first ural (U<sub>1</sub>) and possibly a second ural (U<sub>2</sub>) all fused into a common bone, called the caudal ural centrum. Lundberg and Baskin (1969) show a U<sub>2</sub> in a juvenile of *I. punctatus*. No *nebulosus* in our collection shows a U<sub>2</sub>, but it is most likely that they follow a similar pattern as in *punctatus*. The fusion of these three centra represents an advanced character, typical of many groups of fishes. The complex centrum is prolonged upward by the ossified pleurostyle, a term proposed by Monod (1967) to replace the previously called urostyle.

The hypaxial series consists of a parhypural and six hypurals. *A. nebulosus* has two hypurapophyses, one over the parhypural and a secondary on hypural<sub>1</sub>, a pattern that corresponds to type B of Lundberg and Baskin's (1969) classification.

There are in *A. nebulosus* six hypurals separated into two groups by a wide diastema between hypural<sub>2</sub> and hypural<sub>3</sub>. Hypurals are numbered starting at the bottom, hypural<sub>1</sub> being the largest and hypural<sub>6</sub> the smallest. Hypural<sub>1</sub> and hypural<sub>2</sub> are fused at their bases with the c. u. c. Hypural<sub>3</sub> and hypural<sub>4</sub> join the c. u. c. and are in part closely associated without fusing together. Hypural<sub>5</sub> and hypural<sub>6</sub> are free.

For a history of the terminology of the caudal elements, see Nybelin (1963) and Monod (1968). Rojo (1988, 1991) gives a complete description and relationships of all these elements. The terminology used here is taken from Nybelin (1963) with the modifications and additions made by later authors (Tominaga, 1965, Monod, 1968, and Patterson, 1968).

### **Synonymy**

compound ural centrum

last vertebra McMurrich (1884)

terminal centrum Gosline (1961)

epural

uroneural (Lundberg and Baskin (1969))

\*McMurrich's terminology differs from the modern in the following way:

epural N1 (Neural ?)

parhypural H1

pleurostyle notochord

diastema interval

hypural1 to hypural 6 hemal arches (A to F)

### **D.3 RIBS**

#### **Definition and Description**

The ribs are slender, curved bones, attached by their flattened heads to the parapophyses of precaudal vertebrae. In *A. nebulosus*, they correspond to the dorsal type and their number varies according to that of the precaudal vertebrae, excluding those forming the Weberian apparatus. The sixth vertebra is the first one with a rib (Fig. 26A).

**Synonymy** Lat. costa (pl. costae) Fr. côtes

epipleural ribs

## II.E OPERCULAR SERIES

### Definition and Description

The opercular series consists of the bones that reinforce the opercular membrane. The four most common bones in fishes are: the preopercle, opercle, subopercle and interopercle. The preopercle in *A. nebulosus* is mostly related to the suspensorium (See PREOPERCLE). In *A. nebulosus*, there are only the opercle and interopercle. Both, MacMurrich (1884) and Kindred (1919) report the presence of a small suboperculum mesial to the interopercle, but neither describes it nor it appears in any of their illustrations. I was unable to find the subopercle in any of the specimen studied.

The two suprapreopercles do not belong to this series, in spite of their names (See SUPRAPREOPEECLES).

### E.1 OPERCLE

#### Definition and Description

The opercle is the largest of the opercular series. It is a paired dermal bone with its anterior margin slightly concave; its dorsal margin presents a large alar expansion where the *levator operculi* inserts; while the inferior margin is straight. Close to the posterior apex this margin forms a concave arch where the last branchiostegal ray fits

The dorsal apex is formed by a strong process that articulates with a ball and socket joint with the opercular process of the hyomandibular and serves as attachment for the *dilatator operculi*. The anterior apex tapers to a rounded acute end, while the posterior is truncated in all our specimens (N=24). Cumbaa (1978) reports 19 specimens out of 20 with the posterior apex with rounded corners for *I. nebulosus* (manuscript).

The opercle also articulates with the second suprapreopercle and at its anterior apex with the interopercle.

The opercle is a very strong bone, even in small specimens. Its lateral face is divided into two sections. The anterior triangular in shape, has convergent thin grooves in younger specimens, but deep ones in older individuals. The grooves do not reach the posterior edge. The posterior section, also triangular, has deeper and wider semicircular concentric pits. The mesial face, on the contrary, is smooth and slightly concave.

**Synonymy** Lat. os operculum Fr. opercule, operculaire  
operculum, opercular

**Osteometry** Fig. 28C and Table 22

- AB** Anterior margin length. Minimum distance between its corresponding apices.
- AC** Dorsal margin length. Minimum length between its corresponding apices.
- BC** Inferior margin length. Minimum length between its corresponding apices.
- AD** Height. Minimum distance from the anterior apex to the base of the perpendicular ending at the ventral margin.

### **Iconography**

- Baumgartner, 1982. Fig. 3C
- Lundberg, J. G. 1982. Fig. 27C

## **E.2 INTEROPERCLE**

### **Definition and Description**

The interopercle is a dermal bone located at the anteroventral part of the opercular series. It is a small, elongate quadrangular bone, narrower at the anterior border and ending with two pointed small processes, with which it joins the opercle. The interopercle also articulates through ligaments with the quadrate and the angular. Its dorsal margin abuts the preopercle and its ventral margin lies parallel to the last branchiostegal ray (Fig. 28B)

**Synonymy** Lat. os interoperculum Fr. interopercule  
interopercular, interopercule  
interoperculum Kindred (1919)  
interoperculare (os) Lepiksaar (1981-1983) Manuscript.

### E.3 BRANCHIOSTEGAL RAYS

#### Definition and Description

The branchiostegal rays constitute a set of several long, arched bones of dermal origin whose function is to support the branchiostegal membrane. They are attached to the hyoid arch and vary in number throughout the teleostean fishes. Arratia and Schultze (1990) give 9-10 as the typical number for Ictaluridae.

In *A. nebulosus*, they are distributed into two uneven groups: six rays are connected to the ceratohyal and a two, to the epihyal. The first group can be subdivided into another two subgroups with four rays attached to the outer margin of the ceratohyal and the last two closer to the inner edge. The attachment head of the first six has two lateral expansions, the outer being the longest. The 7th ray has a small head and the 8th has the largest. The latter is also the widest ray and lies under the interopercle and the opercle (Fig. 22A).

In our sample of 17 specimens of *A. nebulosus*, the distribution of all branchiostegals is 8 rays (n = 16) and 9 (n = 1).

MacAllister (1968) gives for *I. nebulosus*, seven in the ceratohyal and two in the epihyal, for a total of 9 rays. Grizzle and Rogers (1976) count 8 for *I. punctatus*. Lundberg (1982) states that "living ictalurids exhibit modal branchiostegal ray counts of eight to ten or eleven, except *Pylodictis* with twelve." (See Tables 30 and 31)

**Synonymy**      Lat. ossa branchiostegalia    Fr. rayons branchiostèges

radii branchiostegi      Lepiksaar (1981-1983) Manuscript

## II.F PECTORAL GIRDLE

#### Definition and Description

The pectoral girdle of actinopterygians connects the paired pectoral fin to the neurocranium. It consists of two related sets of bones of different evolutionary and embryological origin. The first set, called the primary, endoskeletal or endochondral part of the pectoral girdle includes the coracoid, mesocoracoid, metacoracoid, and scapula, while the secondary, exoskeletal or dermal set consists of the posttemporal, the supracleithrum, the cleithrum, and one or two postcleithra. The terms primary and secondary refer to the direct or indirect relationship of the girdle to the fin skeleton; endoskeletal and exoskeletal refer to its position in the body; and endochondral and dermal refer to its ontogenetic origin.



In the family Ictaluridae, the bones of these two sets are reduced in number and size: the endochondral group consists only of the scapula, while the dermal component is made up of the posttemporal and the cleithrum.

**Synonymy**      Lat. cingulum pectorale      Lat. ceinture scapulaire

## F.1 CORACOID

### Definition and Description

The coracoid, the only endochondral bone of the primary pectoral girdle present in Ictaluridae, results from the fusion of the scapula and probably also the mesocoracoid to the original coracoid. It acts firstly as support of the radials and secondly of the fin rays of the pectoral fin (Fig 29).

Two general regions can be distinguished in this bone, one anterolateral with several small processes and the remaining laminar expanding mesially.

The anterolateral section, corresponding to the scapula and representing the scapular process and the “foot-plate” (Brousseau 1976), extends mesially along the anterior border of the coracoid proper. The scapular foramen gives way to the subclavian artery in *I. nebulosus* (Brousseau 1976). A larger foramen lateral to the scapular foramen lodges the ventral process of the pectoral spine when in locking position. The mesocoracoid is represented by the mesocoracoid bridge. The symphyseal or cleithral process extends from the coracoid proper. It joins an equivalent process on the cleithrum and a crest that extends mesially for a fourth or a fifth of the length of the posterior border of the coracoid. The body of the coracoid extends in a fan-like lamina with a scalloped margin divided into from 6 to 8 strong lobes.

The coracoid articulates with its antimeric, the cleithrum, the pectoral spine, and the two radials.

**Synonymy**      Lat. os coracoideum      Fr. coracoïde  
 coracoid                      McMurrich (1884); Cumbaa (1978)  
 scapulo-coracoid              Diogo *et al.* (2001); Arratia (2003b)

**Osteometry** Fig. 29D and Table 23

**AB**      Maximum length. Distance from the most anterior point (excluding the scapular process) to posterior angle of the coracoid symphysis.

**BC**      Coracoid symphysis length.

**N**      Number of lobes.

## F.2 POSTTEMPORAL

### Definition and Description

The posttemporal is a paired dermal bone belonging to the secondary pectoral girdle. According to the most prevalent interpretation, it is formed in the genus *Ameiurus* by the result of the fusion of an original posttemporal, the supraclathrum, and the ossified Baudelot's cartilage. Some authors called it posttemporo-supraclathrum to reflect this interpretation. The posttemporal is the first link connecting the neurocranium to the pectoral fin (Fig. 30).

This bone has four processes: a long dorsal or superior process, which articulates with the extrascapular bone, the epioccipital and that also barely touches the supraoccipital; a short pterotic process linked to the pterotic bone; the transscapular process, that results from the ossification of Baudelot's cartilage, articulates with the basioccipital via a ligament, and finally, the transverse process which meets the Müllerian ramus of the Weberian apparatus (Fig. 26). The ventral part of the bone rests on the cleithrum, preventing excessive downwards and backwards displacement of the girdle

| <b>Synonymy</b>           | Lat. os posttemporale  | Fr. posttemporal |
|---------------------------|--|------------------|
| posttemporal              | Parker (1874); Kindred (1919); Tilak (1963); Alexander (1965); Grizzle and Rogers (1976); Gosline (1977); Cumbaa (1978); Fink and Fink (1981); Howes (1983) and most modern authors. |                  |
| supraclavicula            | Parker(1868)   |                  |
| supraclavicular           | McMurrich (1884)   |                  |
| supraclathrum             | Regan (1911); Hubbs and Miller (1960); Lundberg (1982); Baumgartner (1982); Bornbusch (1991)   |                  |
| posttemporo-supraclathrum | Diogo <i>et al.</i> (2001); Arratia (2003b)  |                  |

### A. Dorsal process

superior process

superior limb

vertical limb McMurrich, (1884)

### B. Transscapular process

Kindred (1919) calls it transscapular in page 90 and transcopular in page 114.

ossified Baudelot's cartilage

mesial limb Lundberg (1975b); Bornbusch (1991)

horizontal limb McMurrich (1884)

lower limb, inferior limb

### **C. Ventral process**

Lundberg (1975b)            the dorsal and pterotic processes together.

**Osteometry**   Figs. 30A and 30D and Table 24

**AB**            Height. Distance between the tip of the dorsal process and the most ventral point of the bone.

**CD**            Width. Distance between the tip of the transscapular process and the lateral margin of the bone in a straight line.

### **Iconography**

Cumbaa (1978)            Fig. 5

### F.3 CLEITHRUM

#### Definition and Description

The cleithrum is the largest paired dermal bone of the pectoral girdle (Fig. 31). It consists of two limbs: the anterior horizontal ventral limb or *ramus* and the posterior antler-like that breaks into three prongs, both linked by a constriction, the isthmus. The limbs are set at an angle that varies in our specimens between 100° and 115°. On its inner face the bone extends mesially into a laminar expansion, called the coracoid wing.

The dorsal margin of the cleithrum is concave and smooth; the inferior, slightly convex, presents a flange that stops the pectoral spine when locked. The posterior margin shows three, more or less pointed, prongs named here dorsal superior, dorsal inferior, and humeral processes. The lateral face of the anterior limb is smooth, while the posterior limb has at its base an oval patch with numerous pits. Grooves, more or less prominent, extend along the three processes, with those on the humeral process being the deepest.

The cleithrum mesial face presents a large articular fossa where the pectoral fin inserts when in the locking position. It also articulates with its antimere, with the coracoid bone, the posttemporal, through the ossified Baudelot's cartilage, the Müllerian ramus of Weberian apparatus, the pectoral radials, and the pectoral spine.

| <b>Synonymy</b> | at. os cleithrum   | Fr. cléithrum  |
|-----------------|--|--|
| cleithrum       | Swinerton (1902); Bertin and Arambourg (1958); Kampf (1961); Nelson (1969) and most authors.   |  |
| clavicle        | Parker (1868); Starks (1930); Bertin (1925);   |  |
| anterior limb   | infraclavicula   | McMurrich (1884)   |
| posterior limb  | mesoclavicula  | McMurrich (1884) but doesn't give a name for the whole bone. |
| posterior limb  | Arratia (2003b) calls it dorsal process, but she also call the two upper prongs, dorsal processes.   |  |
| dorsal process  | anterior process, McMurrich (1884); dorsal process 1 and anterodorsal process, Arratia (2003b), and anterior dorsal process, Tilak (1963).   |  |
| middle process  | median process, McMurrich (1884); dorsal process 2 Diogo <i>et al.</i> (2001); posterodorsal process, Arratia (2003b).   |  |
| humeral process | Inferior process (McMurrich 1884); posterior cleithral process (Lundberg 1982), humero-cubital; (Diogo <i>et al.</i> 2001; Arratia 2003b). Brousseau (1976) calls all three processes dorsal prongs 1-3 and Cumbaa (1978) refers to them as "forks." |  |

articular fossa                      Alexander (1965)  
spinal fossa                          Fine *et al.* (1997)

**Osteometry**    Fig. 31D and Table 25

- AB**      Chordal length. Distance between the anteriormost point of the anterior ramus and the tip of the superior dorsal process.
- AC**      Bone length. Distance between the anteriormost point of the anterior ramus and the tip of the humeral process.
- AD**      Ventral limb length. Distance between the anteriormost point of the anterior ramus and the spinal notch.
- BC**      Maximum spread of the processes. Distance between the tips of the dorsal superior and the humeral processes.

**Iconography**

Cumbaa (1978)                      Fig. 17  
Brousseau (1976)                      Fig. 13, 14, 16, and 18. He has described in detail the anatomy of the pectoral girdle of *I. nebulosus*.

## F.4 RADIALS

### Definition and Description

The radials are small chondral bones that connect the pectoral girdle with the rays of the pectoral fin. Its number has decreased during the evolution of actinopterygians from a total of 13 (*Polyodon*) to two in Ictaluridae. In *A. nebulosus* there are two radials: one, the proximal, thick and curved while the distal is straight, shorter, and thinner. Both radials show on their lateral ends a cartilaginous knob with which they connect with the pectoral fin rays (Fig. 29).

Brousseau (1976) mentions four small distal cartilaginous radials, the most lateral articulating “by its proximal depression with the scapular process,” in *A. nebulosus*.

**Synonymy**      Lat. os radiales      Fr. radials

### Iconography

Brousseau (1976)      Figs. 14, 15 and 19.

## F.5 PECTORAL SPINES

### Definition and Description

The pectoral spines of Ictaluridae, the result of the strong calcification of the first soft ray of the pectoral fins, present two distinct sections, the proximal end, the “head,” and the long distal shaft, both separated by a deep depression called, the basal recess (Fig. 32). The head of the spine has three processes (dorsal, anterior, and ventral) actively engaged in the locking mechanism of the spine. Hubbs and Hibbard (1951) have described, in *A. lambda*, several smaller processes, also present in *A. nebulosus*. In *A. nebulosus*, the shaft is flattened dorsoventrally with small serrations along the anterior border and strong dentations on its posterior border. Its pointed end is covered and overrun by epidermal tissue. The strong dentations correspond to three types: antrorse, located usually in a proximal position with points directed backward; erect, in the middle, and, in a distal position, the retrorse dentations with their points curved forward, but there is a wide variability in their distribution. The spine articulates with the “scapular” section of the coracoid bone and with the cleithrum in a ball-and-socket joint.

Hubbs (1940) states that the length of the pectoral spine decreases in ictalurids from south to north, an observation corroborated by Yerger and Relyea (1968), without either source providing any data.

The two pectoral spines in conjunction with the dorsal spine probably provide an effective defense mechanism against predators.

**Synonymy**      Lat. spina pinnae pectoralis      Fr. épine pectorale

(The following synonymy is in part extracted from Hubbs and Hibbard (1951)).

**A. Dorsal process**      Hubbs and Hibbard (1951 and most authors)  
semicircular ridge      McMurrich (1884)  
“ $\delta$ ” process      Sörensen (1898)  
arched crest      Burkenroad (1931)  
process “2”      Merriman (1940)

**B. Anterior process**      Hubbs and Hibbard (1951 and most authors)  
superior terminal process      McMurrich (1884)  
“ $\beta$ ” process      Sörensen (1898)  
process “1”      Merriman (1940)  
ventral process      Paloumpis (1963) [probably a typographical error]

**C. Ventral process**      Hubbs and Hibbard (1951 and most authors)  
inferior terminal process      McMurrich (1884)

**Osteometry**      Fig. 32B and Tables 26 and 27

- AB**      Spine length. Minimum distance between the most proximal point and the most distal point of the spine.
- BC**      Head length. Minimum distance between the most anterior point of the ventral process and the most posterior point of the dorsal process.
- DE**      Head height. Distance between the most dorsal point of the dorsal edge and the most ventral point of the ventral process.

### **Cross references**

Paloumpis (1963) proposed several measurements. His *base line* of the shaft is our “spine length” and his *ventral (=anterior) process to dorsal articulating*

*surface distance*, our “head length.” He obtained a ratio of 0.24 to 0.25 between HL/SpL. No individual values of his sample of 15 specimens (total length from 51 to 215 mm) were given. Table 26 shows our values for a sample of 23 specimens varying from 0.19 to 0.29 (TL 132 and 295mm) for the left spine. Table 27 shows HL/SpL values for the right spine varying from 0.19 to 0.30 for 21 specimens

HL/SL values of four large specimens on loan from Royal Ontario Museum oscillate between 0.21 and 0.27 (left spine) and from 0.22 to 0.25 (right). No fish size was given.

Alexander (1965) recommends taking the length of the three spines and using their sum value as a percentage of the standard length. His results, based on different species of catfishes, do not show any trend.

### **Iconography**

|                   |                      |
|-------------------|----------------------|
| Reed 1924.        | Figs. 1 and 12       |
| Paloumpis 1963.   | Fig. 2D and plate 1D |
| Brousseau 1976.   | Figs. 15 and 19      |
| Baumgartner 1982. | Fig. 6D              |



## II.G PELVIC GIRDLE

### Definition and Description

The pelvic girdle in Ictaluridae consists of two symmetrical bones of chondral origin named pelvic bones or *basipterygia*. These bones join together through a cartilaginous band forming a large laminar plate, called pelvic or basal plate. There is a large foramen or two small ones on each plate (Fig. 33).

Each pelvic bone has two anterior processes: one anteromesial that grows forwards and inwards to join its antimere and another anterolateral that grows straight forward. Some Ictaluridae have also a lateral process, reduced in *A. nebulosus* to a protrusion, more or less pronounced. A third, the posterior cartilaginous process present, the ischiac process, even in adults of *A. nebulosus* of our sample.

The pelvic bones articulate with each other by a symphysis that allows restricted movement. They present on their posterior edges an acetabular facet for the attachment and support of the rays of their corresponding pelvic fins.

**Synonymy**      Lat. os basipterygium    Fr. ceinture pelvienne

**Osteometry**    Fig. 33 and Table 28.

**AB.**      Length. Maximum distance between the most anterior point of the anterolateral process and the most posterior of the basal plate.

**CD**      Width. Maximum distance between the extreme point of the lateral process and the most mesial point of the basal plate.

### Iconography

Lundberg, J. G. 1982. Fig 40C

## II.H DORSAL SPINE

### Definition and Description

The dorsal spine results from the fusion and ossification of the first two hemitrachs (Fig. 34). In *A. nebulosus*, it differs from the pectoral spines in being slender, shorter, and with very small serrations. Its anterior surface presents at its base a middle process, two lateral condyles, and a foramen through which passes a thin loop of bone from the first pterygiophore (= nuchal plate 1). This spine is the second, since the first one has been reduced to the dorsal plate shaped as an inverted V (Fig. 34 B).

The lateral condyles articulate with the lateral processes of the first pterygiophore and with the well ossified vestige of the first dorsal spine. Each arm of the dorsal plate articulates with the first pterygiophore through a single ligament. Its vertex fits between two small prominences on the spine, to which it is attached by two lateral ligaments.

The posterior surface of the spine presents a recess similar to the one in the pectoral spine and a suture line corresponding to the fusing of the two original hemitrachs. When erect, the dorsal spine forms, together with the two pectoral spines, a defensive triangle against predators.

The dorsal spine has been used to estimate the age of the channel catfish (*A. punctatus*) by Marzolf (1955) and Sneed (1951).

**Osteometry** Fig. 34A and Table 29.

**AB** Length. Minimum distance from the anteriormost point of the middle process to the most posterior point of the spine.

## II.I PTERYGIOPHORES

### Definition and Description

Pterygiophores, the bony elements that support the rays of the dorsal and anal fins, are formed from cartilage and ossify into three independent units: proximal, middle, and distal, the latter being the closest to the fin. Very often, these units coalesce into two or even one piece. The vestigial pterygiophores in front of the dorsal fin which do not connect to a fin ray are usually called supraneurals.

### I.1 Dorsal fin pterygiophores

#### Definition and Description

The dorsal pterygiophores in *A. nebulosus* are closely related to the Weberian apparatus and the dorsal fin. (Fig. 34A).

The dorsal pterygiophores are preceded by a triangular thin supraneural that protrudes between the two prongs of the bifid neural spine of the fourth vertebra. Its posterior margin sutures with the anterior margin of the first pterygiophore. In *A. nebulosus*, this first supraneural does not reach the supraoccipital spine as it does in *I. punctatus*.

The first pterygiophore, the largest, has a long pointed body and a distal “head” formed by a knob flanked by two wide lateral processes. The knob fits between the arms of the vestigial first dorsal spine. This knob ends into a thin ring of bone that runs through a foramen at the base of the dorsal spine (Fig. 34Cb). The dorsal spine has two processes which articulate with similar lateral processes on the second pterygiophore, whose posterior margin sutures with the anterior margin of the first pterygiophore. The proximal ends of both pterygiophores fit into the hollow base of the neural arch of the fourth vertebra.

The six remaining pterygiophores are similar in shape as those of most teleosts and decrease progressively in size. Their vertices fit into the bifid neural arches of the fifth to the tenth vertebrae.

#### Synonymy

|                                 |   |
|---------------------------------|---|
| pterygiophores                  | Most authors  |
| first and second pterygiophores | Anterior and posterior neural plates (Grande and Shardo 2002); First and second dorsal plates (Arratia 2003b) |
| supraneural                     | first pterygiophore Arratia (2003b) first radial McMurrich (1884) anterior radial Grande and Shardo (2002)    |

|               |   |
|---------------|---|
| interspinalia | McMurrich (1884)  |
| actinophores  | Cope (1890)   |
| radials       | Goodrich (1930); Grande and Shardo (2002); Arratia (2003) |
| supraneurals  | Arratia (1987)  |

## **I.2 Anal pterygiophores**

### **Definition and Description**

The anal pterygiophores (Fig. 35) are of normal shape similar to the last pterygiophores of the dorsal fin. In both cases the three original units: proximal, middle, and distal coalesce into one. In *A. nebulosus*, there are eighteen pterygiophores supporting an equal number of fin rays. The last small fin ray, called a stay, is usually not counted as a ray.

### III. BIBLIOGRAPHY

- Alexander, R. McN. 1964. Structure of the Weberian Apparatus of the Siluri. *Proc. Zool. Soc. London.* 142:419-440. 12 figs.
- Alexander, R. McN. 1965. Structure and function in the catfish. *J. Zool.* 148:88-152.
- Allis, E. Ph. 1898. The Morphology of Certain Bones of the Cheek and Snout of *Amia calva*. *J. Morphology.* Vol, XIV. No. 3.
- Appelget, J. and Smith, L. L. Jr. 1951. 1951. The determinations of age and rate of growth from vertebrae of the channel catfish, *Ictalurus lacustris punctatus*. *Trans. Amer. Fish. Soc.* 80(1950):119-139.
- Arratia, G. 1992. Development and variation of the suspensorium of primitive catfishes (Teleostei: Ostariophysii) and their phylogenetic relationships. *Bonn. Zool. Monogr.* 32:1-148.
- Arratia, G. 1987. Description of the primitive family Diplomystidae (Siluriformes, Teleostei, Pisces): morphology, taxonomy and phylogenetic implications. *Bonn. Zool. Monogr.* 24:1-120.
- Arratia, G. 2003a. Catfishes head skeleton: An overview. In: *Catfishes*. Vol. 1:1-45. 12 figs.
- Arratia, G. 2003b. The Siluriform Postcranial Skeleton: An Overview. In: *Catfishes*. Vol. 1:121-157. 11 figs.
- Arratia, G. and L. Huaquín. 1995. Morphology of the lateral system and of the skin of diplomystid and certain primitive loricaroid fishes and systematics and ecological considerations. *Bonn. Zoo Monogr.* 36:1-110
- Arratia, G. and Schultze, H-P. 1990. The urohyal: development and homology within Osteichthyans. *J. Morphology.* 203:247-282. 20 figs.
- Arratia, G. and Schultze, H-P. 1991. Palatoquadrate and its ossifications. Development and homology within Osteichthyes. *J. Morphology.* 208:1-81.
- Arratia, G. and Gayet, M. 1995. Sensory canals and related bones of Tertiary Siluriform crania from Bolivia and North America and comparison with recent forms. *J. Vertebrate Paleontology.* 15(3):482-505. 13 figs.
- Bailey, Reeve M. *et al.* 1991. A list of the Common and Scientific names of Fishes of the United States and Canada. *Amer. Fish. Soc. Special Publ.* No. 6 Fifth ed.
- Bamford, B. T. W. 1948. Cranial development of *Galeichthys felis* (Ariidae). *Proc. Zool. Soc. London.* 118:364-391.
- Baumgartner, J. V. 1982. A New Fossil Ictalurid Catfish from the Miocene Middle Member of the Truckee Formation, Nevada. *Copeia.*1982 (1):36-46.

- Berg, L. S. 1940. Classification of fishes both recent and fossil. *Akademiia Nauk S. S. R. Moscow*. 5(2): Part I (in Russian) 87-345; Part II. (in English):345-511.
- Bertin, L. 1925. Reserches bionomiques, biométriques et systématiques sur les épinoches (Gastérostéides). *Ann. Océanogr. Monaco*. 2:1-204.
- Bertin, L. & C. Arambourg. 1958. Systématique des poissons. In: *Traité de Zoologie*. Edited by P. P. Grassé, 13 (3): 1967-1983.
- Böker, H. 1913. Der Schadel von *Salmo salar*. Ein Beitrag zur Entwicklung des Teleostierschadel. *Anat. Hefte*. 49:359-396.
- Bornbusch, A. H. 1991. Monophyly of the catfish family Siluridae (Teleostei: Siluriformes), with a critique of previous hypotheses of the family's relationships. *Zool. J. Linnean Society*. 101:105-120. 5 figs.
- Bridge, T. W. 1877. The cranial osteology of *Amia calva*. *J. Anat. Physiol*. 11:605-622. London.
- Bridge, T. W. and Haddon, A. C. 1889. Contribution to the Anatomy of Fishes. I. The air-bladder and Weberian ossicles in the Siluridae. *Proc. Roy. Soc. London*. 46:309-328.
- Brousseau, R. A. 1976. The Pectoral Anatomy of Selected Ostaryophysi. II. The Cypriniformes and Siluriformes. *J. Morph*. 150:79-119. 19 figs. 2 tables.
- Burchenroad. M. D. 1931. Notes on the sound-producing marine fishes of Louisiana. *Copeia*. 1931:20-28.
- Calovich, F. E. and Branson, B. A. 1964. The Supraethmoid-ethmoid complex in the American Catfishes, *Ictalurus* and *Pylodictis*. *The American Midland Naturalist*. 335-347. 5 figs.
- Chardon, M.; Parmentier, E. and Vandewalle, P. 2003. Morphology, Development and Evolution of the Weberian Apparatus in Catfishes. In: *Catfishes*. 1:71-120. 16 fig.
- Coburn, M. M. and Grumbach, P. G. 1998. Ontogeny of the Weberian Apparatus in the Armoured Catfish *Corydoras paleatus* (Siluriformes: Callichthyidae). *Copeia*. 1998(2):301-311. 9 figs.
- Cope, E. D. 1890. The homologies of the fins of fishes. *Am. Nat*. 24: 401-423
- Cumbaa, S. L. 1978. The Comparative Osteology of the Ictaluridae: Identification Key to Certain Canadian species. Zooarchaeological Identification Center. *Nat. Mus. Hist. Sciences*. (Manuscript).
- Cuvier, G. 1825. *Reserches sur les Ossements Fossiles*. 3rd ed. Paris.
- Davis, D. S. and Browne, S. 1997. *The Natural History of Nova Scotia* (vol. 2). Nimbus and the Nova Scotia Museum, co-publishers, 304 pp.
- Daget, J. 1964. Le crâne des Téléostéens. *Mém. Mus. Hist. Nat. Sér. A* 31:163-341.
- De Beer, G. 1937. *The Development of the Vertebrate Skull*. Clarendon Press. Oxford.

- Devaere, S.; Teugels, G. G.; Adriens, D. Huysentruyt, and Verraes, W. 2004. Redescription of *Dolichaballes microphthalmus* (Poll 1942) (Siluriformes, Clariidae). *Copeia*. 2004(1): 108-115. 4 figs.
- Diogo, R.; Oliveira, C. and Chardon, M. 2000. The origin and transformation of the palatine-Maxillary System of catfish (Teleosts): Siluriformes): an example of macroevolution. *Netherlands J. Zool.* 30(3):373-388. 6 figs.
- Diogo, R.; Oliveira, C. and Chardon, M. 2001. On the Osteology and Myology of the Catfish Pectoral Girdle, with a Reflection on Catfish (Teleostomi: Siluriformes) Plesiomorphies. *J. Morphology*. 249:100-125.15 figs.
- Diogo, R.; Parmentier, E. and Vandewalle. P. 2003. Morphology, Development and Evolution of the Weberian Apparatus in Catfish. In: *Catfishes*. Vol. 1:71-120. 16 figs.
- Eaton, Theodore H. Jr. 1948. Form and Function in the head of the channel catfish, *Ictalurus lacustris punctatus*. *J. Morphology* 83:181-194.
- Ferraris, Carl J. Jr. 2007. Checklist of catfishes, recent and fossil (Osteichthyes: Siluriformes), and catalogue of siluriform primary types. *Zootaxa*, 1418: 1-628.
- Fine, M.; Friei, J. P.; McElroy, D.; King, Ch. B.; Loesser, K. E. and Newton, S. 1997. Pectoral spine locking and sound production in the Channel catfish *Ictalurus punctatus*. *Copeia*. 1997(4):777-790. 8 figs.
- Fink, V. and Fink, W. 1981. Interrelationships of the ostariophysan fishes (Teleostei). *Zool. J. Linnaean Society*. 72:297-353. 23 figs.
- Fürbringer, K. 1897. Über die spino-occipitalen Nerven der Selachier und Holocephalen und ihre vergleichende Morphologie. *Fests. z. 70. Geburtsag v. C. Gegenbaur*. 3:349-788. 8 plates.
- Gauga, R. K. 1966. Studies on the Osteology of Indian Sisorid Catfishes. II. The skull of *Glyptothorax cavia*. *Copeia*. 1966(4):802-810. 5 figs.
- Gaupp, E. 1906. Das Hyobranchialskelett der Wirbelthiere. *Ergeb. Anat.* 14:808-1048.
- Goodrich, E. S. 1930. *Studies on the structure and development of vertebrates*. London. 836 pp. (Reprinted by Dover Public. New York, 1958).
- Gosline, W.A. 1961. The perciform caudal skeleton. *Copeia*. 1961 (3):265 - 270
- Gosline, W. A. 1975. The palatine-maxillary mechanism in catfishes with comments on the evolution and zoogeography of modern Siluroids. *Occas. Papers California Acad. Sci.* 120:31. 1 fig. 1 table.
- Gosline, W. A. 1977. The structure and function of the dermal pectoral girdle in bony fishes with particular reference to ostariophysines. *J. Zool. London*. 183:329-338.
- Grande, Lance. 1987. Redescription of *Hypsidoris faronensis* (Teleostei: Siluriformes), with a reassessment of its phylogenetic relationships. *J. Vertebrate Paleontology*. 7(1):24-54.

- Grande, T. and Shardo, J. D. 2002. Morphology and Development of the Postcranial Skeleton in the Channel Catfish, *Ictalurus punctatus* (Osteroiophysi: Siluriformes). *Fieldiana: Zoology New Series*. June 28:1-30. 12 figs. 2 tables.
- Grande, L. and Lundberg, J. G. 1988. Revision and redescription of the genus †*Astephus* (Siluriformes: Ictaluridae) with a discussion of its phylogenetic relationships. *J. Vertebrate Paleontology*. 8(2):139-171. 19 figs. 2 tables.
- Gregory, W. K. 1933. *Fish Skulls. A Study of the Evolution of Natural Mechanisms*. Noble Offset Printers (1959) Inc. New York.
- Grizzle, J. M. and W. A. Rogers, 1976. Anatomy and Histology of the Channel Catfish. *Agricultural Experiment Station*. Auburn University. Auburn, Alabama. i-v+1-94 pp. 171 figs.
- Haines, R. W. 1937. The posterior end of Meckel's cartilage and related ossifications in bony fishes. *Q. J. Microsc. Sci.* 80(1):1-38.
- Hardman, M. and Page, L. M. 2003. Phylogenetic Relationships among Bullhead Catfishes of the Genus *Ameiurus* (Siluriformes: Ictaluridae). *Copeia*. 2003(1):20-30. 4 figs. 3 tables
- Harrington, R. W. 1955. The osteocranium of the American cyprinid fish, *Notropis bifrenatus*, with an annotated synonymy of teleost skull bones. *Copeia*. 1955 (4):267-290.
- Holmgren, N. and Stensiö, E. A. 1936. Kranium und Visceralskelett der Akranier, Cyclostomen und Fische. In: *Handbuch der vergleichenden Anatomie der Wirbeltiere*, von L. Bolk. Berlin/Wien. Bd. 4:1-1016.
- Hoz, E. de la y Arenas, G. D. 1976. Contribución al estudio de la osteología cefálica de *Merluccius guyi*. *Anales Mus. Hist. Nat. Valparaíso*. 9:115-125.
- Howes, G. J. 1983. Problems in catfish anatomy and phylogeny exemplified by the Neotropical Hypoenthalmidae (Teleostei: Siluroidei). *Bull. Br. Nat. His. (Zool.)*. 45(1):1-39. 27 figs.
- Hubbs, C. L. and Hibbard, C. W. 1951. *Ictalurus lambda*, a New Catfish, Based on a Pectoral Spine from the Lower Pleistocene of Kansas. *Copeia*. 1951(1):9-14. 3 plates.
- Hubbs, C. L. and Miller, R. R. 1960. *Potamarius*, a new Genus of Ariid Catfishes from the Fresh Waters of Middle America. *Copeia*. 1960(2):101-111. 5 figs.
- Hubbs, C. L. 1940. Speciation of fishes. *Amer. Nat.* 74:198-211.
- Huxley, T. H. 1864. Theory of the vertebrate skull. The Croonian Lecture. *Proc. Roy. Soc. London*. 9:381-433.
- Jarvik, E. 1967. The homologies of frontal and parietal bones in fishes and tetrapods. In: Problèmes actuels de Paléontologie. *Cool. Int. du Centre Nat. Recherche*. 181-213 pp. I-IV Plates.
- Jenkins, D. B. 1977. A Light Microscopic Study of the Sacculus and Lagena on Certain Catfishes. *Amer. J. Anatomy*. 150:605-5303 figs. 5 plates.



- Jenkins, D. B. 1979. A Transmission and Scanning Microscopic Study of the Saccule in Five Species of Catfishes. *Amer. J. Anatomy*. 154:81-102. 5 plates.
- Jollie, M. 1962. *Chordate morphology*. New York. xiv+478 pp. 569 figs.
- Jollie, Malcolm. 1986. A primer of bone for the understanding of the acanthopterygian head and pectoral girdle skeletons. *Can. J. Zool.* 64:365-379.
- Jones, P. W.; Martin, F.D. and Hardy, J. D. Jr. 1978. Development of Fishes of the Mid-Atlantic Bight. Vol. 1. Acipenseridae through Ictaluridae. *Fish and Wildl. Serv.* U. S. Department of the Interior. Ictalurus nebulosus 319-322.
- Jordan, D. S. and Evermann, B. W. 1896. The Fishes of North and Middle America. Part I. *U. S. Nat. Mus. Bull.* 47(1):1-1240.
- Jordan, D. S. and B. W. Evermann. 1896. The Fishes of North and Middle America. *Bull. U.S. National Museum*. 17. Part 1. Washington.
- Kampf, W. D. 1961. Vergleichende funktionsmorpologische Untersuchungen an den Viscerocranien einiger räuberisch lebender Knochenfische. *Zool. Beitr.* (N.F.). 6:391-496.
- Kindred, J. E. 1919. The skull of *Ameiurus*. *Illinois Biol. Monographs*. V(1):1-120.
- Krumholtz, L. A. 1943. A Comparative Study of the Weberian Ossicles in North American Ostariophysan Fishes. *Copeia*. 1943(1):33-40. 3 plates.
- Kusaka, T. 1974. *The urohyal in fishes*. University of Tokyo Press. Tokyo. 310 pp.
- Lekander, B. 1949. The sensory line system and the canal bones in the head of some Ostariophysii. *Acta Zoologica*. 30:1-131.
- Lepiksaar, J. 1981-1983. *Osteology*. I. Pisces. Manuscript.
- Lewis, W. M. 1949. The use of vertebrae as indicators of the age of the northern black bullhead *Ameiurus melas melas* (Rafinesque). *Iowa State Coll. J. Sci.* 23(2):209-218.
- Lundberg, J. G. 1970. The evolutionary history of North American catfishes, Family Ictaluridae. *Unpl. Ph.D. Dissertation. Univ. Ann Arbor*. Michigan. 524 pp.
- Lundberg, J. G. 1975a. The fossil catfishes of North America. *Papers on Paleontology*. Univ. Michigan. W. Hibbard Memorial Vol. 2. 11:1-iv,1-51.
- Lundberg, J. G. 1975b. Homologies of the Upper Shoulder Girdle and Temporal Region Bones in Catfishes (Order Siluriformes), with Comments on the Skull of the Helogeneidae. *Copeia*. 1975. (4):66-74.
- Lundberg, J. G. 1982. The Comparative Anatomy of the Toothless Blindcatfish, *Trogloglanis pattersoni* Eigenmann, with a Phylogenetic Analysis of the Ictalurid Catfishes. *Misc. Publ. Mus. Zool. Univ. Michigan*. 188:1-85. 42 figs.
- Lundberg, J. G. 1991. *Gladioglanis conquistador* N. Sp. from Ecuador with Diagnosis of the Subfamilies Rhamdiinae Bleeker and Pseudopimelodinae N. Subf. (Siluriformes: Pimelodidae). *Copeia*. 1991(1):190-209. 9 figs. 1 table.

- Lundberg, J. G. 1992. In: *Systematics, Historical Ecology and North American Freshwater Fishes*. Ed. Richard L. Mayden. Stanford University Press. Stanford, California. 12:393-419.
- Lundberg, G. J. and Baskin, J. N. 1969. The Caudal Skeleton of the Catfishes, Order Siluriformes. *Ann. Museum Nov.* 2398. 1-49. 9 figs.
- McAllister, D. E. 1968. The Evolution of the Branchiostegals and associated opercular, gular, and hyoid bones, and the Classification of Telostome Fishes, Living and Fossil. *Nat. Mus. Bull.* 221:1-239.
- Matveiev, B. 1929. Die Entwicklung der Vorderen Wirbel und des Weberschen Apparates bei Cyprinidae. *Zool. Jahrb. (Jena)*. 51(4):463-534. 6 plates.
- McMurrich, J. O. 1884. The Osteology of *Amiurus catus*. *Proc. Can. Inst.* 2:270-310.
- Marzolf, R. C. 1955. Use of the pectoral spines and vertebrae for determining age and rate of growth of the channel catfish. *J. Wildlife Manag.* 19(2):243-249.
- Meckel, J. F. 1824. *System der vergleichenden Anatomie*.
- Merriman, Daniel. 1940. The osteology of the striped bass (*Roccus saxatilis*). *Ann. Mag. Nat. Hist.* 5: 55-64.
- Monod, Th. 1968. Le complexe urophore des Poissons Téléostéens. *Mém. Inst. Fondamental d'Afrique Noire*. 81. vol I and I1: 1-705. 989 figs. Ifan Dakar.
- Müller, J. 1842. Beobachtung zur vergleichenden Anatomie der Wirbelsäule. *Arch. Anat. Physiol.* 1853:260-316.
- Mundell, R. L. 1975. An illustrated Osteology of the channel catfish (*Ictalurus punctatus*). Midwest Archaeol. Center. *Occas. Papers in Anthropology*. 2:1-10.
- Nawar, G. 1954. On the anatomy of *Clarias lazera*. *J. Morph.* 94:551-585. 8 figs.
- Nelson, G. J. 1969. Gill arches and the phylogeny of fishes, with notes on the classification of vertebrates. *Bull. Am. Mus. Nat. Hist.* 141(4):479-552.
- Nielsen, E. 1942. Studies on Triassic fishes from East Greenland. I. *Glaucolepis* and *Boreosomus*. *Palaeozoologica Groenlandica*. 138:viii+394 pp. 78 figs. 30 plates.
- Norman, J. R. 1926. The development of the chondrocranium of the eel (*Anguilla vulgaris*), with observations on the comparative morphology and development of the chondrocranium in bony fishes. *Phil. Trans. R Soc. London. Ser. B.* 214:369-464.
- Nybelin, O. von. 1963. Zur Morphologie und Terminologie des Schwanzskelettes der Actinopterygier. *Ark. Zool.* 15 (2) : 485-516.
- Owen, R. 1848. *Homologies of the vertebrate skeleton*. London
- Paloumpis, A. A. 1963. A key to the Illinois species of *Ictalurus* (Class Pisces) based on pectoral spines. *Trans. Illinois State Acad. Sci.* 56(1):129-133. Springfield. 3 figs.

- Paloumpis, A. A. 1964. A key to the Illinois species of *Ictalurus* (Class Pisces) based on the supraethmoid bone. *Trans. Illinois Academy Sciences*. 57(4):253-255. 2 figs.
- Parker, W. K. 1868. *A monograph on the Structure and Development of the Shoulder-girdle and Sternum in the Vertebrata*. London.
- Parker, W. K. 1874. On the structure and development of the skull in the salmon (*Salmo salar* L.). The Bakerian Lecture. *Phil. Trans, Roy. Soc. London*. Part I. 163:95-145. 8 tables.
- Patterson, C. 1968. The caudal skeleton in lower Liassic pholidophorid fishes. *Bull. Br. Mus. Nat. Hist.* 16 (5): 203- 239.
- Patterson, C. 1975. The braincase of pholidophorid and leptolepid fishes, with a review of the actinopterygian braincase. *Phil. Trans. Roy. Soc. London. B*. 269(899):275-579.
- Parker, W. K. 1874. On the structure and development of the skull in the salmon (*Salmo salar* L.) *Phil. Trans. Roy. Soc. London. Part I*. 163:95-145.
- Pehrson, T. 1944. Some observations on the development and morphology of the dermal bones in the skull of *Acipenser* and *Polyodon*. *Acta Zoologica. Stockholm*. 25:27-48.
- Pina, M.D. and Heok, Ng. 2004. The Second Ural Centrum in Siluriformes and its implication for the Monophyly of Superfamily Sisoroidea (Teleostei, Ostaryophysi). *Amer. Museum Nov.* 3347:1-23.
- Reed, H. C. 1924. The morphology and growth of the spines of siluroid fishes. *J. Morphology*. 38:431-451. 14 figs.
- Regan, C. T. 1911. The classification of the teleostean fishes of the order Ostariophysi. *Ann. Mag. Nat. Hist.* 8(8):553-577.
- Ridewood, W. G. 1904. On the cranial osteology of the fishes of the families Elopidae and Albulidae. *Proc. Zool. Soc. London*. 2:35-81.
- Rojo, A. L. 1988. *Diccionario Enciclopédico y Multilingüe de Anatomía de Peces*. Instituto Esp.de Oceanografía. Monografía no. 3. 564 pp. 64 figs. Madrid.
- Rojo, A. L. 1991. *Dictionary of Evolutionary Fish Osteology*. CRC Press. Boca Raton, Ann Arbor, Boston, London. 273 pp. 45 figs.
- Rojo, A. L. 2002. Morphological and Biometric Study of the Bones of the Buccal Apparatus of Some Nova Scotia Fishes of Archaeological Interest. *Nova Scotia Museum Curatorial Report*. 96.
- Sagemehl, M. 1885. Beiträge zur vergleichenden Anatomie der Fische. III. Das Cranium der Characiniden nebst allgemeinen Bemerkungen über die mit einem Weberschen Apparat versehenen Physostomenfamilien. *Morph. Jahrb.* 10:1- 119.
- Schaeffer, B. and C. Patterson. 1984. Jurassic Fishes from the Western United States, with comments on Jurassic Fish Distribution. *Amer. Mus. Novitatis*. 2796:1-86.

- Schultze, H-P. and Arratia, G. 1989. The composition of the caudal skeleton of Teleosts (Actinopterygii: Osteichthyes). *Zool. J. Linnean Soc.* 97:189-231. 19 figs.
- Scott, W. B. and Crossman, E. J. 1973. Freshwater Fishes of Canada. *Fish. Res. Bd. of Canada. Bull.* 184. 966 pp.
- Sewertzoff, A. N. 1928. The head skeleton and muscle of *Acipenser ruthenus*. *Acta Zool. Stockholm.* 9: 193-319.
- Smith, C. L. 1962. Some Pliocene Fishes from Kansas, Oklahoma and Nevada. *Copeia.* 1962(3):505-315. 6 figs.
- Smith, H. G. 1956. A Comparative Study of the Neurocranium and Weberian Apparatus of the Ictalurid. M. Th. (Manuscript) 77 pp. 27 figs. 5 tables.
- Sneed, K. E. 1951. A method for calculating the growth of Channel catfish *Ictalurus palustris punctatus*. *Trans. Amer. Fish. Soc.* 80(1950):174-183.
- Sörensen, W. 1898. Some remarks on Dr. Thilo's memoir on "Die Umbildungen am den Gliedmassen der Fische." *Morpholog. Jahrb.* 25:170-189, 6 figs.
- Srinivasachar, S. R. 1958. Development of the skull in catfishes. Part V. Development of the chondrocranium in *Arius jella* Day (Ariidae) and *Plotosus canius* Ham (Plotosidae) with an account of their interrelationships. *Morphol. Jahrb.* 99:986-1016, 10 figs.
- Stannius, H. 1854. Handbuch der Anatomie der Wirbelthiere. Berlin.
- Starks, E. C. 1901. Synonymy (sic) of the fish skeleton. *Proc. Washington Acad. Sci.* 3:507-539. 2 figs.
- Starks, E. C. 1930. The primary shoulder girdle of the bony fishes. *Stanford Univ. Publ. Uni. Ser. Biol. Sci.* 4(3):149-239.
- Stensiö, H. H. 1902. A contribution to the morphology of the teleostean head skeleton based upon a study of the development of the three-spined stickleback *Gasterosteus aculeatus* ) *Q. J. Microscopy Sci.* 45:503-593.
- Stensiö, E. A. 1947. The sensory lines and dermal bones of the cheek in fishes and amphibians. Stockholm: Alqvist and Wiksells [*K. Sven. Vetenskapsakad. Handl. Ser. 3. Bd.* 24(3)].
- Swinnerton, H. H. 1902. A contribution to the morphology of the teleostean head skeleton based on the development of the three-spined stickleback (*Gasterosteus aculeatus*). 1 table. *Q. J. Microscop. Sci.*
- Taylor, W. R. 1954. Records of fishes in the John N. Lowe collection from the Upper Peninsula of Michigan. *Misc. Publ. Mus. Zool. Univ. Mich.* 87:50
- Tavolga, W. N. 1962. Mechanisms of sound production in the ariid fishes. *Galeichtys* and *Bagre*, *Bull. Am. Mus. Nat. Hist.* 124:1-30.
- Teugels, G. G. 1966. G. G. 1996. Taxonomy, phylogeny, and biogeography of Catfishes (Ostariophysi: Siluroidea; an overview) *Living Aquatic Resources.* 9:9-34.

- Thomas, S. C. (1994-2008) Osteometry of Selected Freshwater Fish Species: Bioarchaeological Research Osteometric Manual III. An on-going osteometric procedure manual. (Manuscript report).
- Tilak, R. 1963. Studies on the nematognathine pectoral girdle in relation to taxonomy. *Amer. Mag. Nat. Hist.* 131:145-155. 9 figs.
- Weber, E. H. 1820. De aure et auditu hominis et animalium. I. De aure animalium aquatiliium. Leipzig: Gerhard Fleischer
- Wright, R. R. 1884. The relationship between the Air-bladder and Auditory organ in Amiurus. *Zool. Anzeiger.* 7.
- Yerger, R. W. and Relyea, K. 1968. The Flat-bullheads (Pisces: Ictaluridae) of the Southeastern United States and a new Species of *Ictalurus* from the Gulf Coast. *Copeia.* 1968(2):361-383. 3 figs. 6 tables.

## **IV. APPENDICES**

**Appendix I Illustrations of *A.nebulosus* bones**

**Appendix II Biometric tables**

### **IV.I APPENDIX I**

#### **ILLUSTRATIONS OF *AMEIURUS NEBULOSUS* BONES**

All illustrations were made to scale by hand with pencil by the author. All bones were from fresh specimens. No archaeological material was used. The small anatomical features were observed using a stereoscopic microscope at 20 maximum magnification. Most bones are, except when indicated, drawn as they are oriented in the fish as it lies flat on its right side and its head to the observer's left side.

Every bone has been drawn at least once. Bones with distinct anatomical features on their faces has been represented twice: in lateral and mesial view or dorsal and ventral. One more drawing has been used to indicate the articulations with adjacent ones and a fourth drawing shows how the selected dimension or dimensions were measured. These measurements were always taken in a straight line and never following the curvature of the fish or bone.

The bones' outline cannot be taken to be identical for every specimen. There are always small differences due to age, size, sex, and health. We assume the growth to be isometric, but this situation has not been studied here. Other dissimilarities occur especially in the outline of bones with laminar expansions, such as the hyomandibular, quadrate, metapterygoid, etc.

Large foramina for the passage of nerves or blood vessels are sometimes split into two smaller foramina. Very often the size, number, and relative position of the foramina are not symmetrical in paired bones.

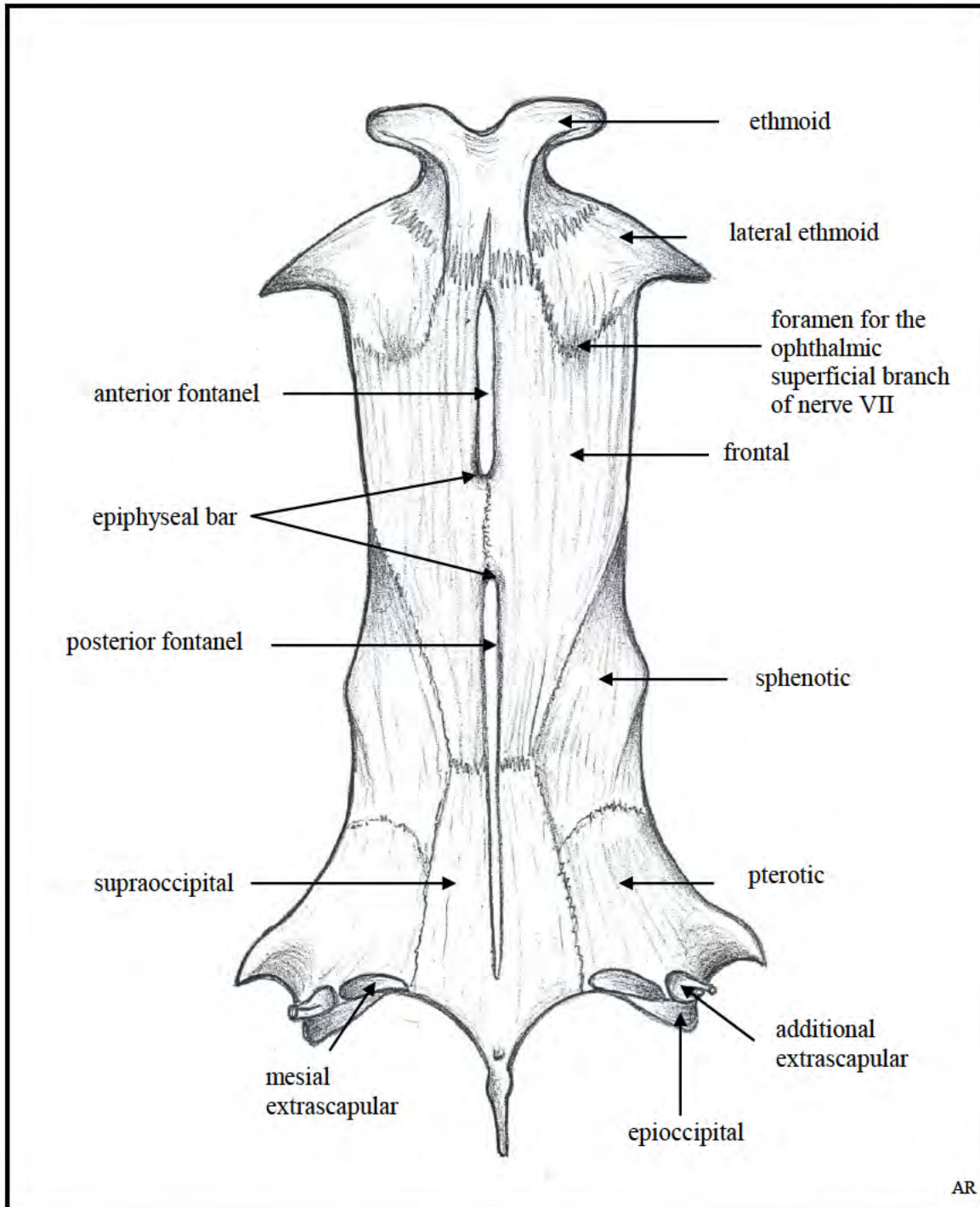

Figure 1. **Neurocranium**. Dorsal view. NSMNH # 88122.

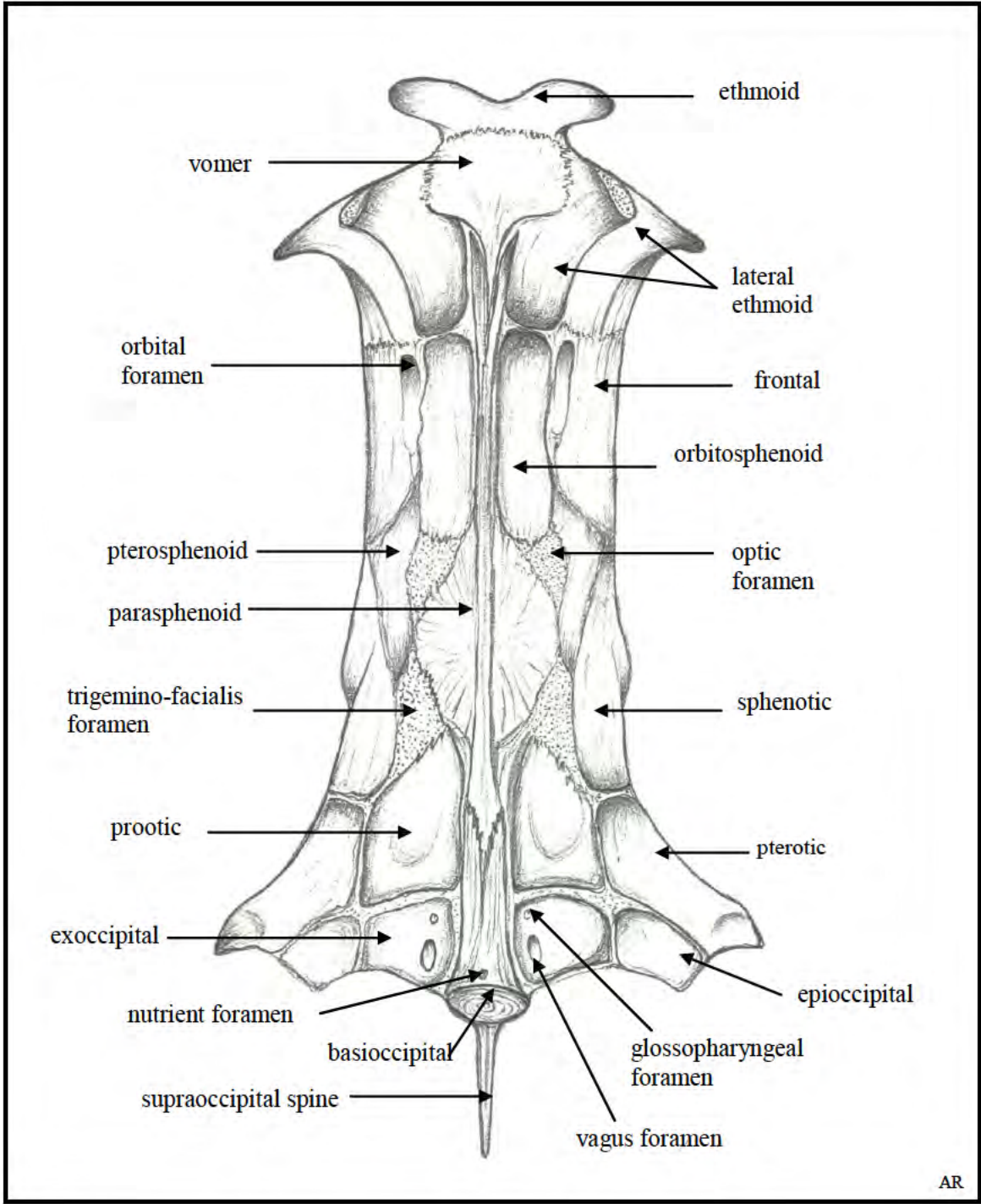

Figure 2. Neurocranium. Ventral view. NSMNH #88122



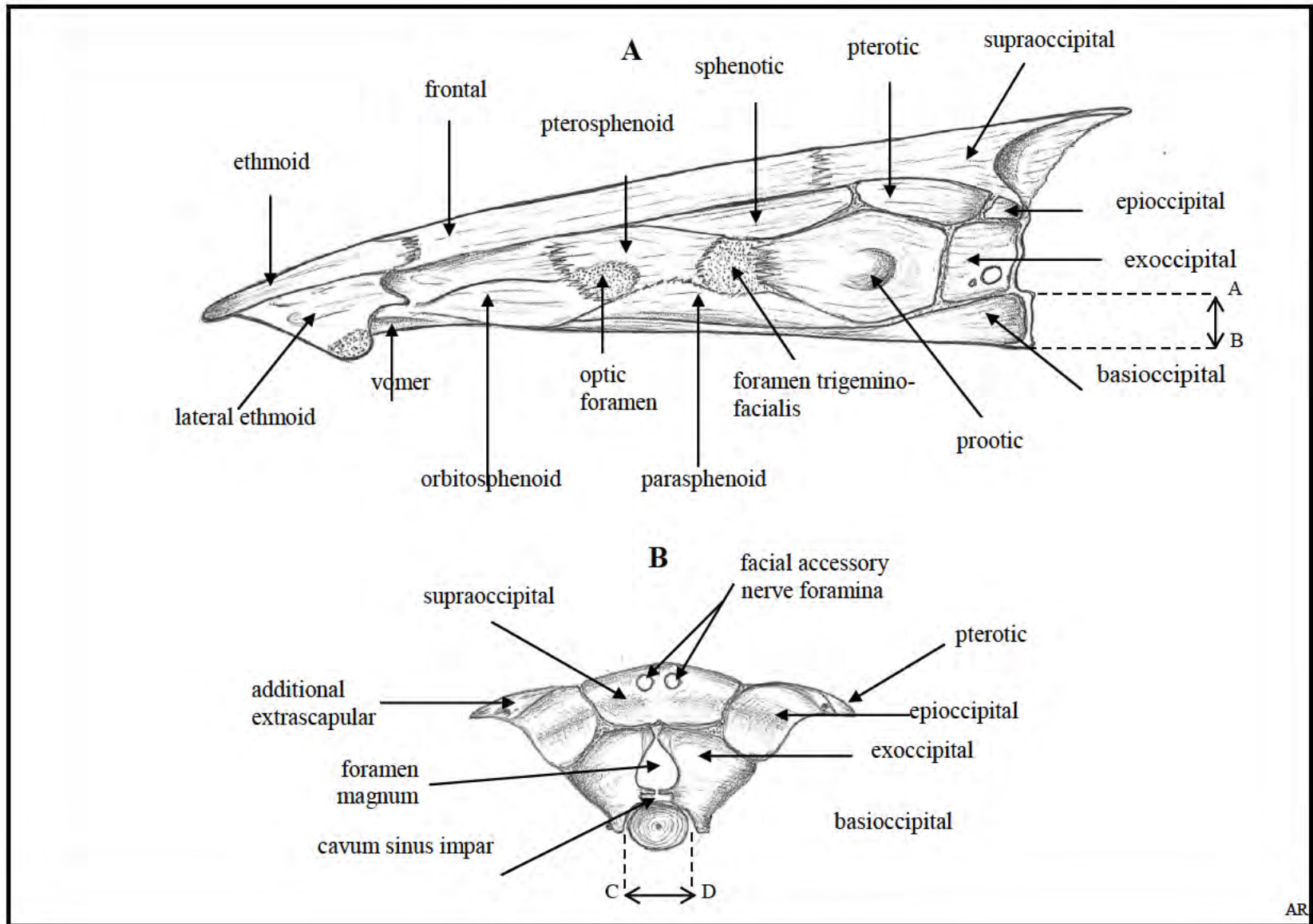

Figure 3. **Neurocranium**. **A**. Lateral view. **AB**. Height of basioccipital condyle. **B**. Posterior view. **CD**. Width of basioccipital condyle. NSMNH #88122.

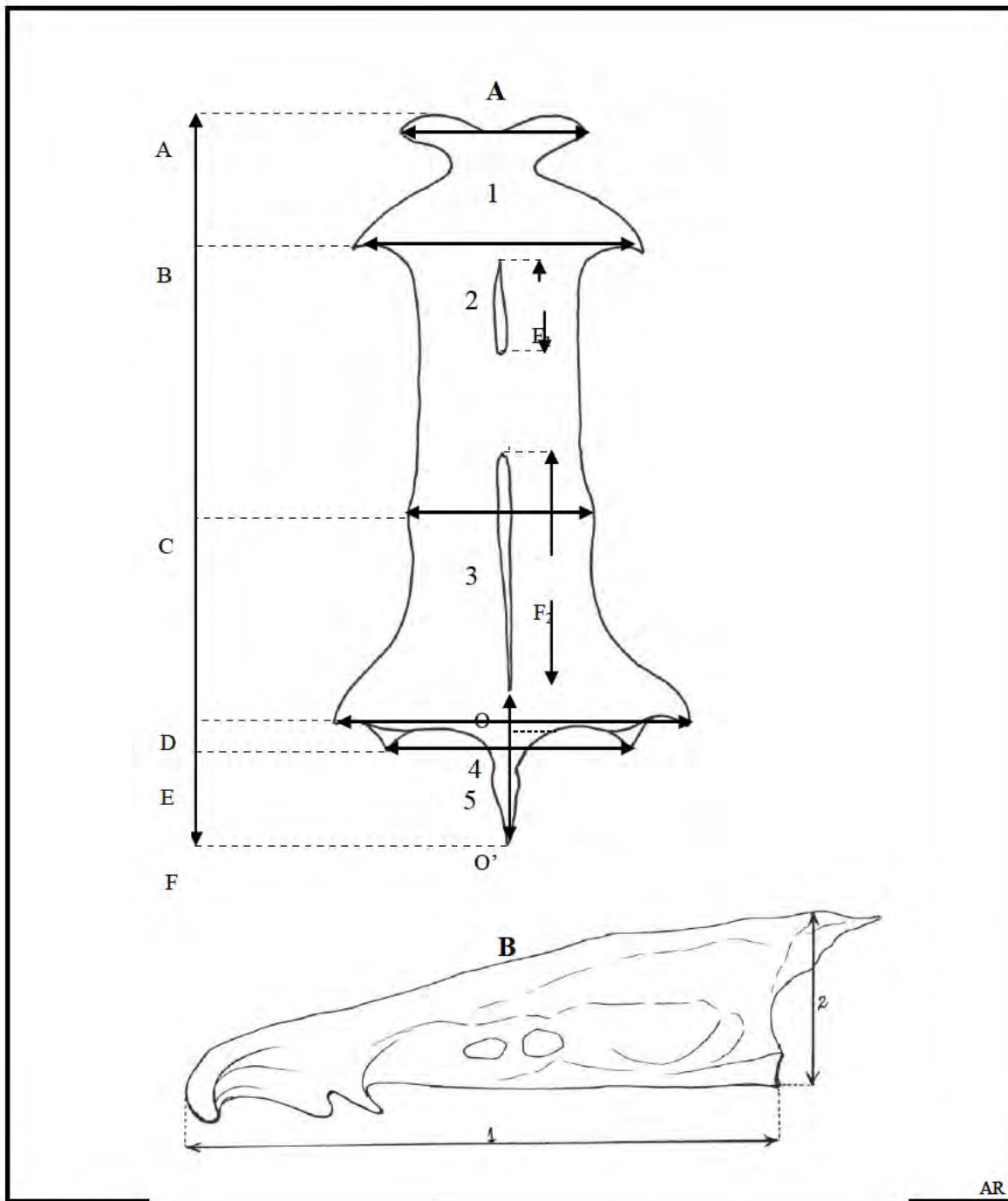

Figure 4. Neurocranium measurements. AF. Neurocranium dorsal length. F<sub>1</sub>. Length of anterior fontanel. F<sub>2</sub>. Length of the posterior fontanel. AB. Ethmoid to lateral ethmoid wing length. AC. Ethmoid to sphenotic wing length. AD. Ethmoid to pterotic wing length. AE. Ethmoid to epioccipital wing length. OO.' Length of the occipital spine. #1. Ethmoid width. #2. Width at the lateral ethmoids. #3. Width at the sphenotics. #4. Width at the pterotics. #5. Width at the epioccipitals. **B.** Neurocranium ventral length #1. Neurocranium height #2.

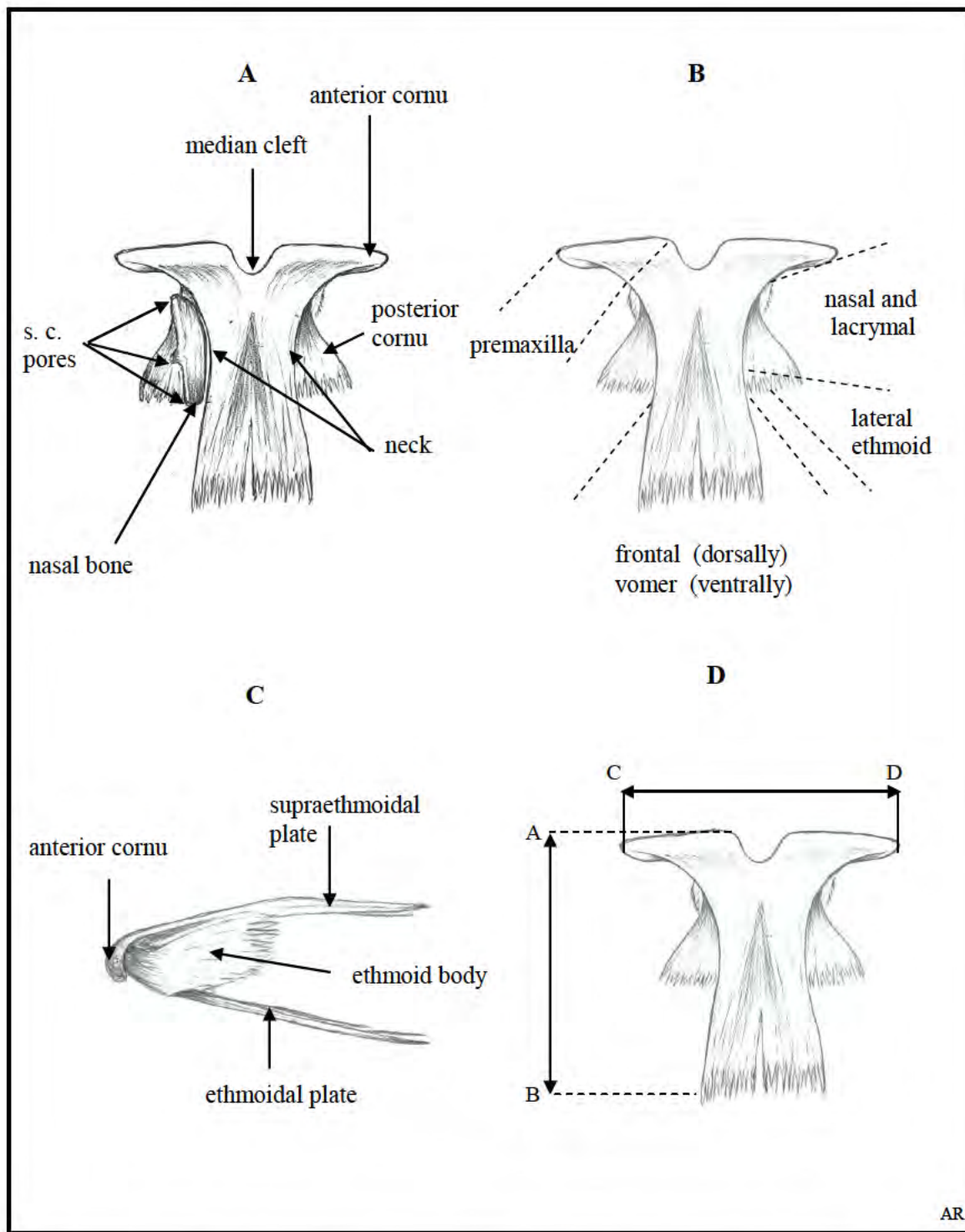

Figure 5. **Ethmoid and nasal.** A. Dorsal view. B. Ventral view. Articulations. C. Lateral view. D. Measurements: AB. Length. CD. Width. NSMNH #88122. The dash line indicates a ventral connection.

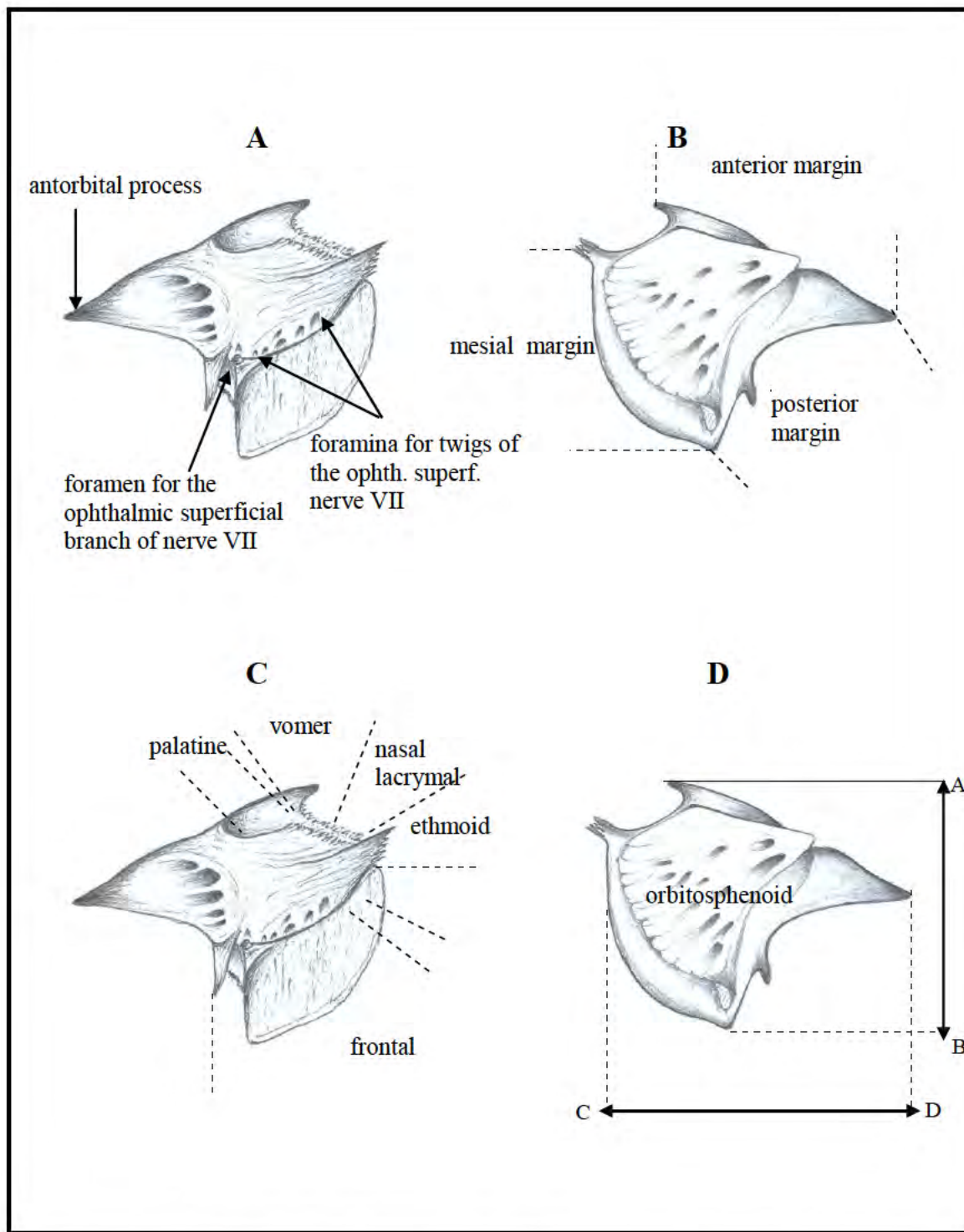

Figure 6. **Lateral ethmoid**. **A**. Dorsal view. **B**. Ventral view. Margins. **C**. Articulations. **D**. Dimensions: AB. Length. CD. Width. NSMNH #88122. The dash lines refer to ventral connections.

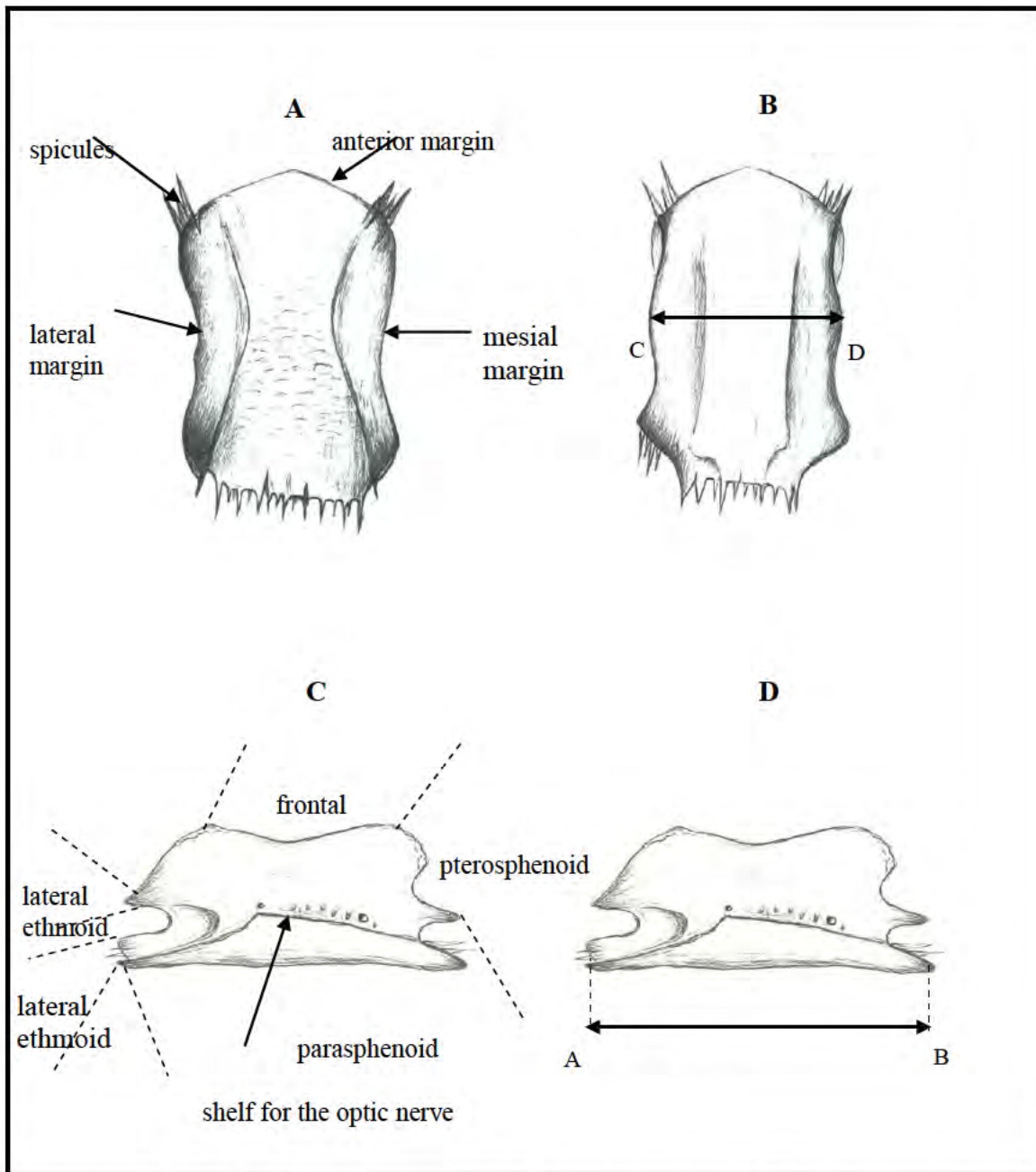

Figure 7. **Orbitosphenoid**. **A**. Dorsal view. **B**. Ventral view. **C**. Lateral view. Articulations. **B** and **D**. Dimensions: AB. Length. CD. Width. NSMNH #88122.

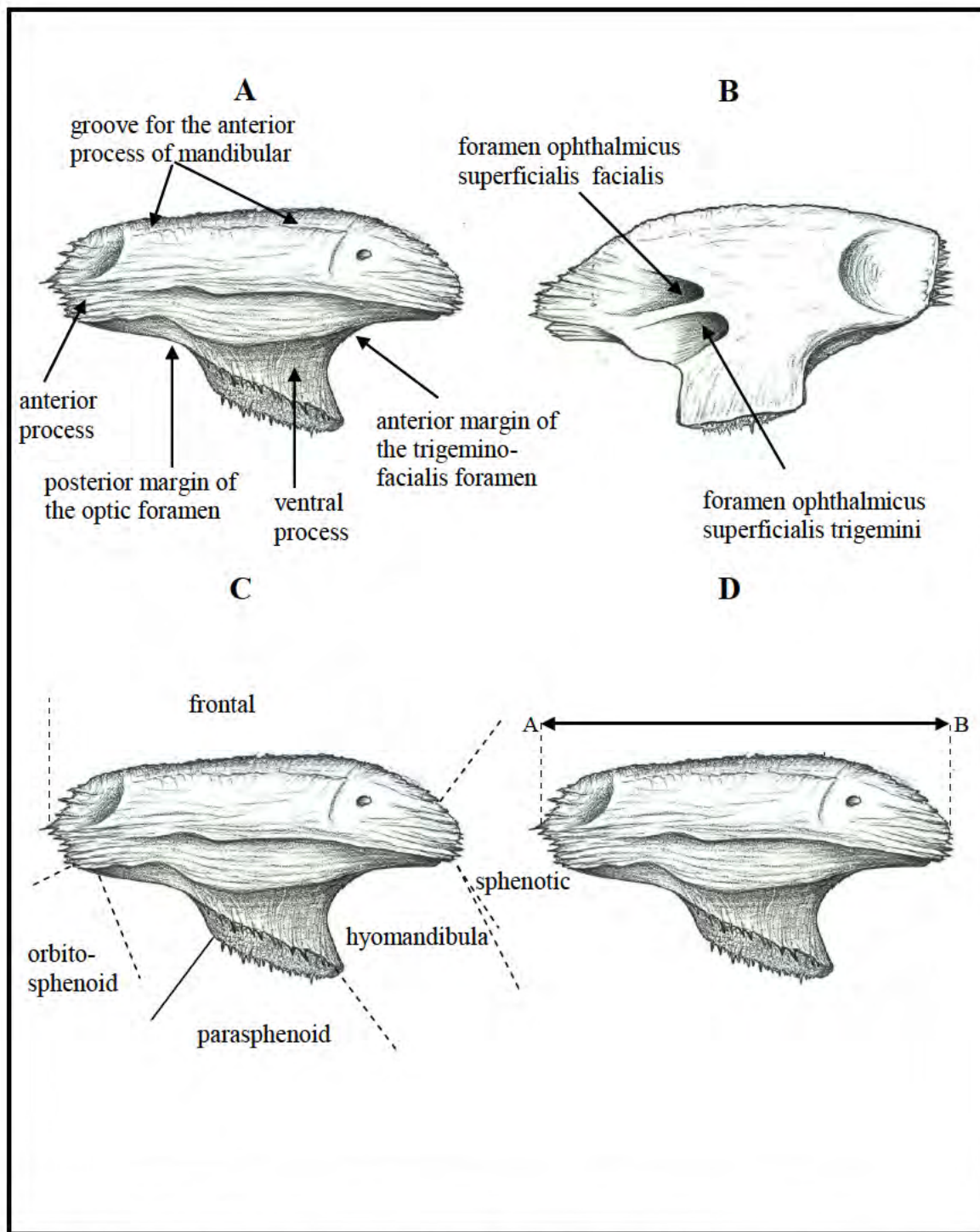

Figure 8. **Pterosphenoid**. A. Lateral view. B. Mesial view. C. Articulations. D. Dimension. AB. Length. NSMNH #88122.

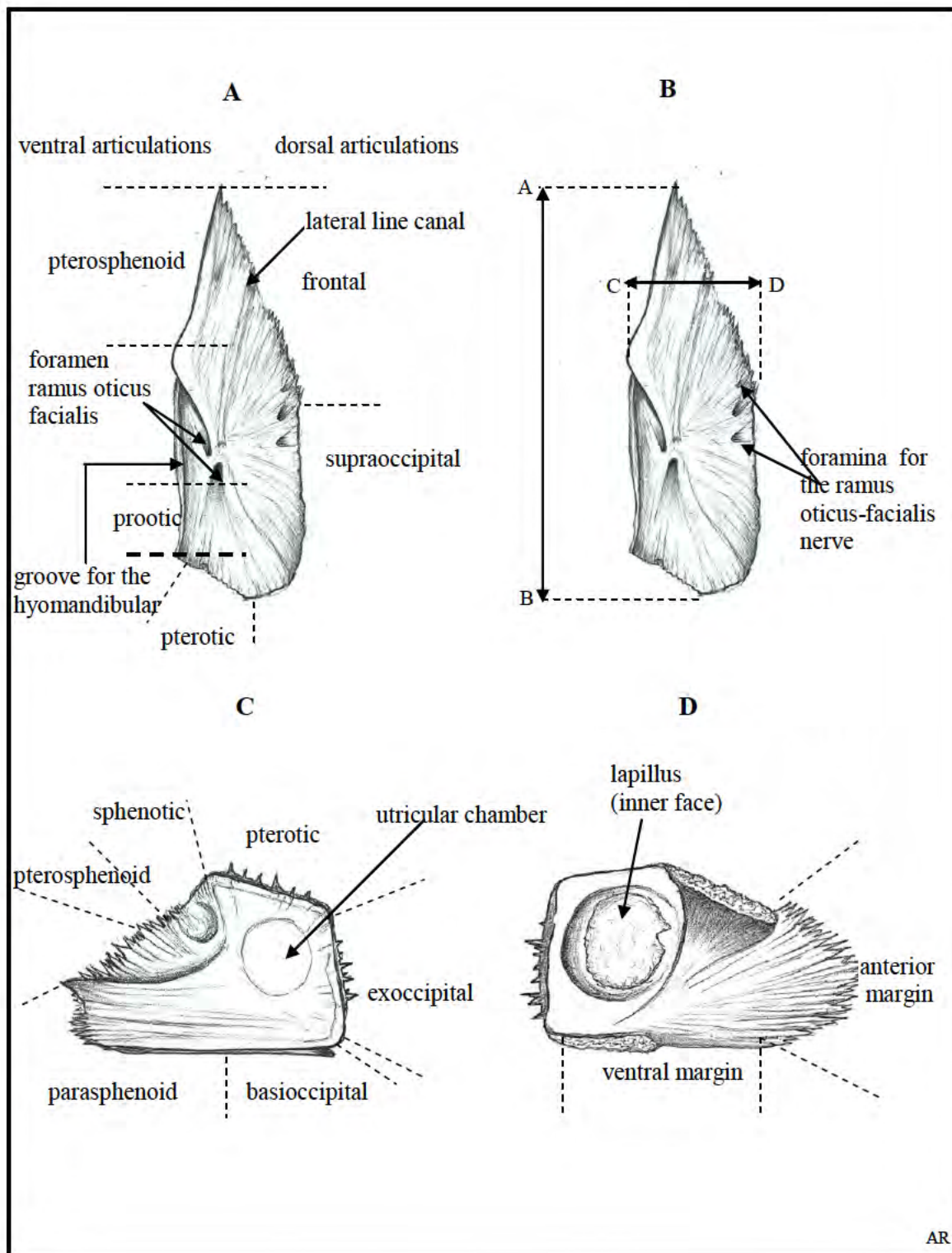

Figure 9. **Sphenotic**. **A**. Dorsal view. Articulations. **B**. Dimensions: AB. Length. CD. Width. **Prootic**. **C**. Lateral view. Articulations. **D**. Mesial view. Margins. NSMNH #88122. Dash lines refer indicates a ventral connection.

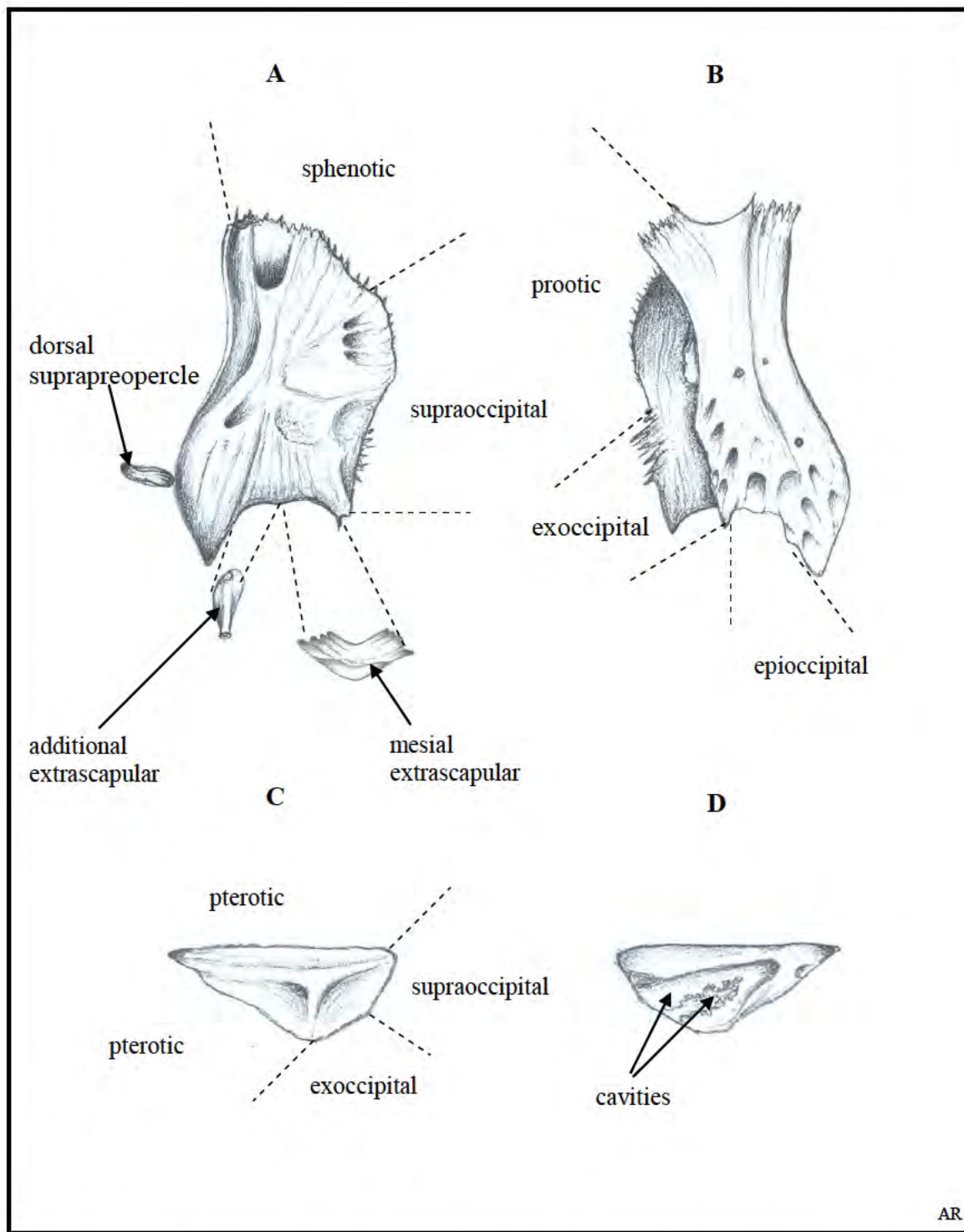

Figure 10. **Pterotic**. **A**. Dorsal view. Articulations. **Suprapreopercle**. **Additional and mesial extrascapulars**. **B**. Ventral view. Articulations. **C**. **Epioccipital**. Dorsal view. **D**. Ventral view. NSMNH#88122.



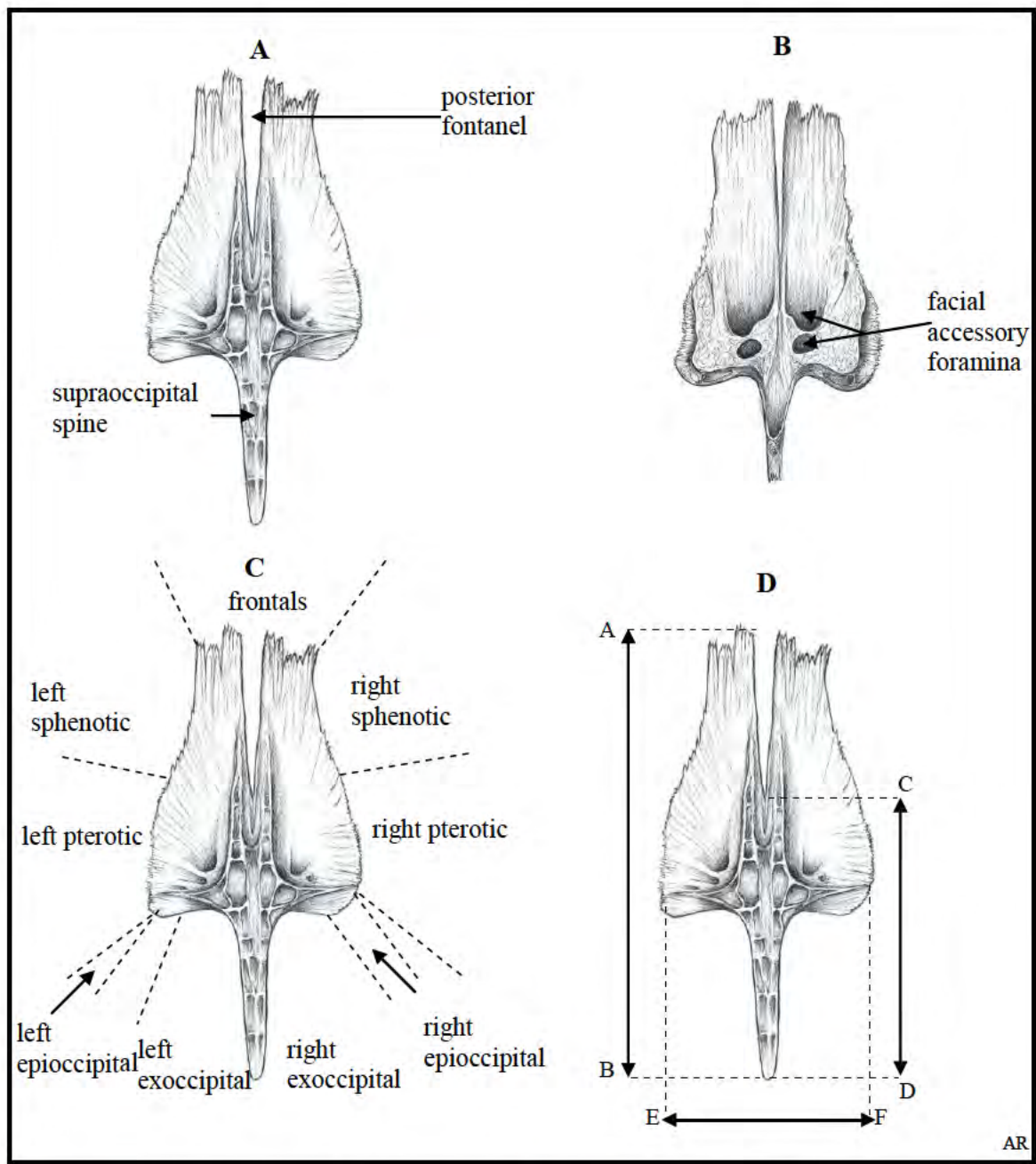

Figure 11. **Supraoccipital.** **A.** Dorsal view. **B.** Ventral view. **C.** Articulations. **D.** Dimensions: AB. Length. CD. Spine length. EF. Width. NSMNH #88122. The dash lines represent ventral articulations.

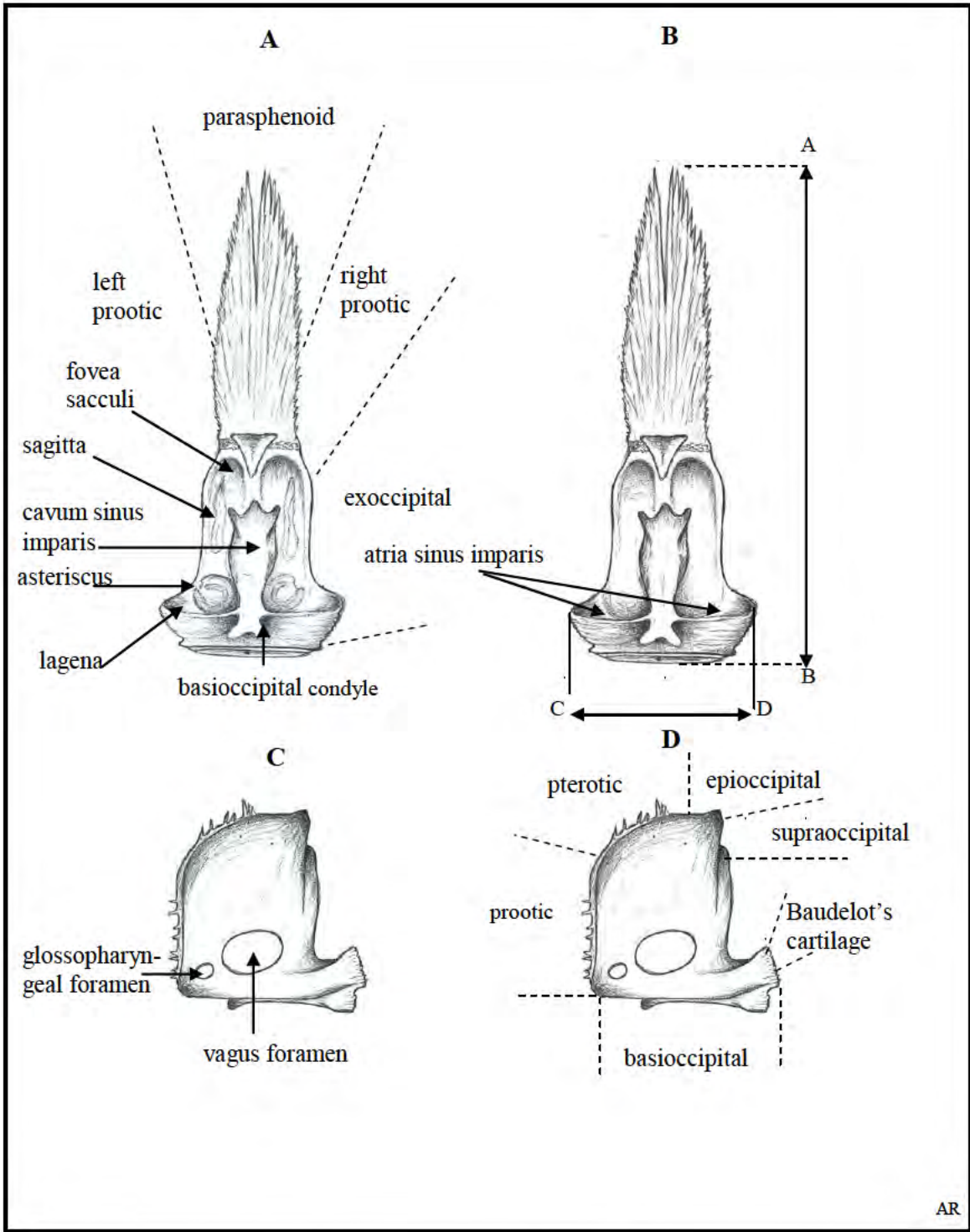

Figure 12. **Basioccipital**. **A.** Dorsal view. Articulations. **B.** Dimensions: AB. Length. CD. Width. **Exoccipital**. **C.** Lateral view. **D.** Articulations. NSMNH # 88122.

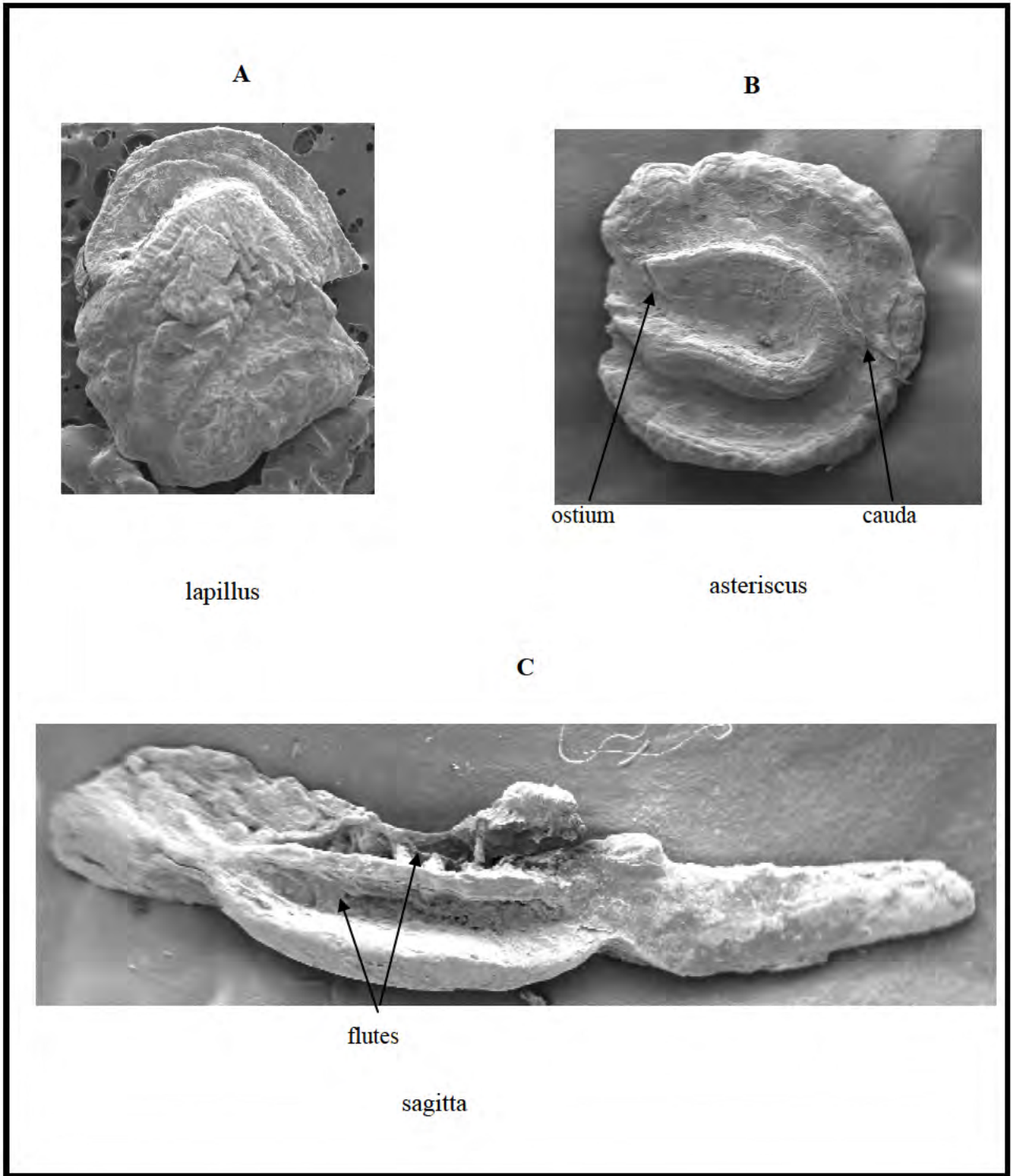

Figure. 13. Otoliths (right side). **A. Lapillus** (2.7 mm) NSMNH# 87477. Lateral view. **B. Asteriscus** (1.8 mm). Mesial view. NSMNH # 87824. **C. Sagitta** (4.2 mm). Dorsal view. NSMNH # 87824.

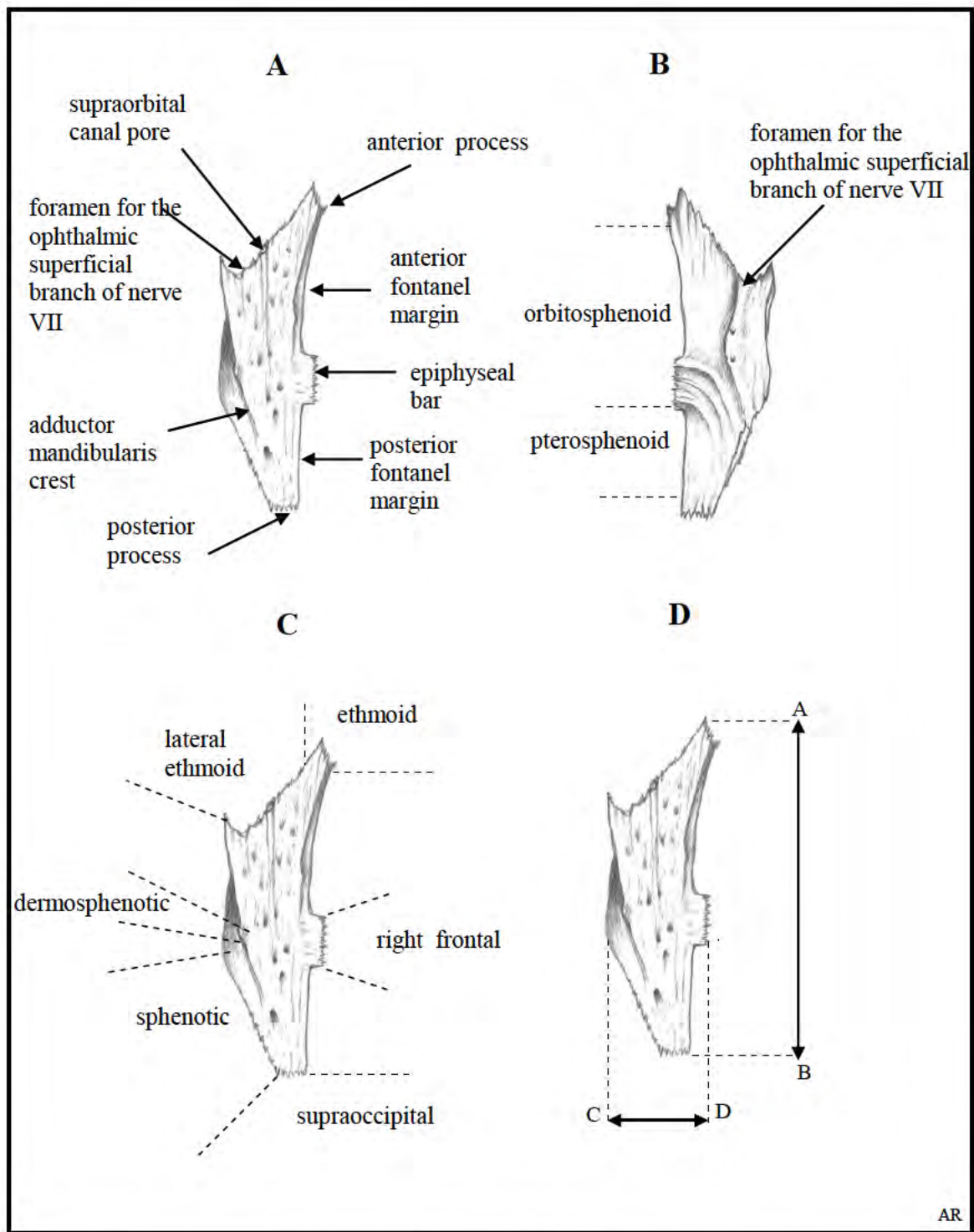

Figure 14. **Frontal.** **A.** Dorsal view. **B.** Ventral view. Ventral articulations. **C.** Dorsal articulations. **D.** Dimensions: AB. Length. CD. Width. NSMNH #87473.

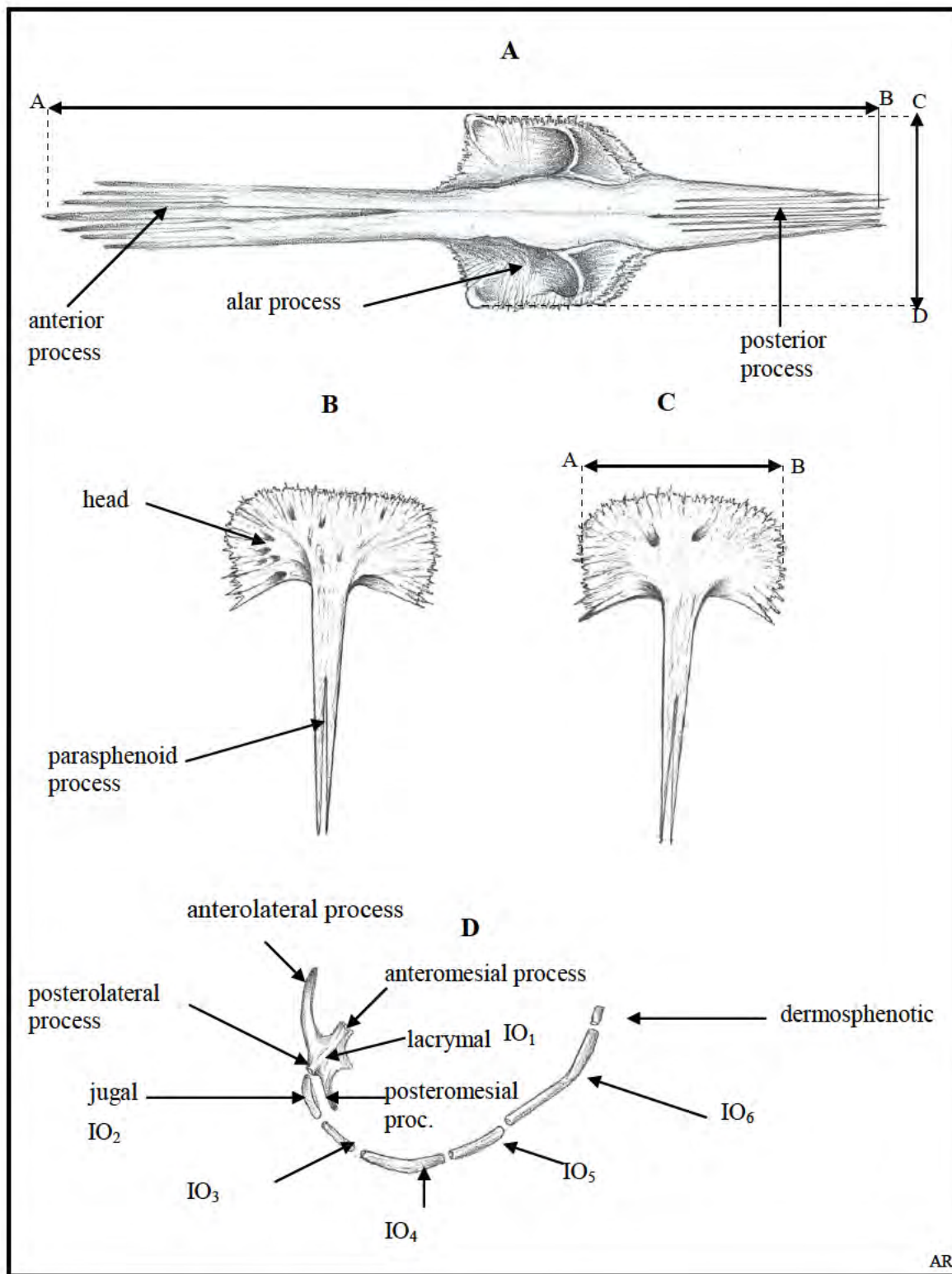

Figure 15. **A. Parasphenoid.** NSMNH#88122. Dorsal view. Dimensions: AB. Length. CD. Width. **B. Vomer.** NSMNH#87919. Dorsal view. **C.** Ventral view. Dimension: AB. Width. **D. Circumorbitals.** Lateral view. NSMNH#87475.

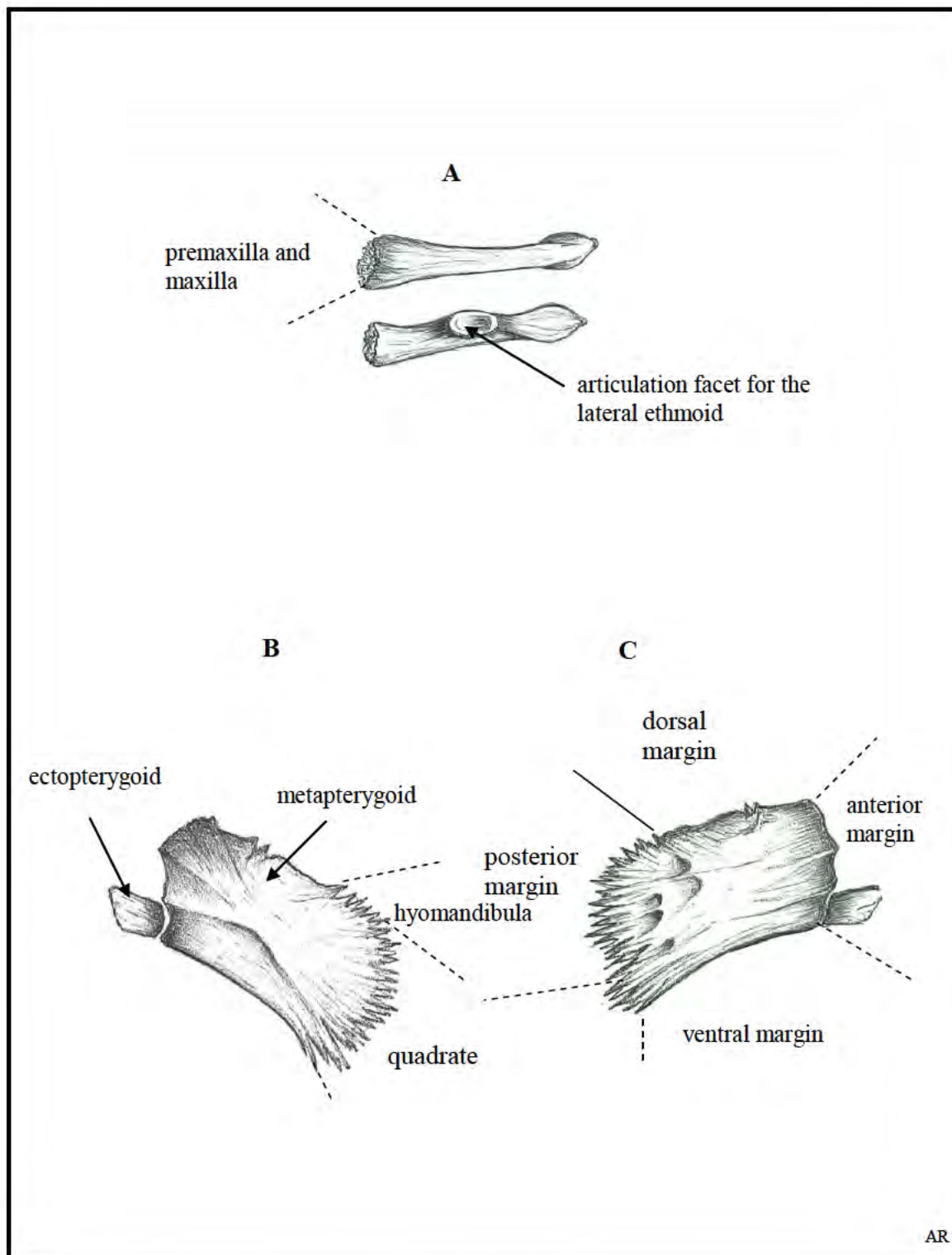

Figure 16. **A. Palatine.** Lateral and mesial views. **B. Ectopterygoid and metapterygoid.** Lateral view. Articulations. **C.** Mesial view. Margins. NSMNH#88122.

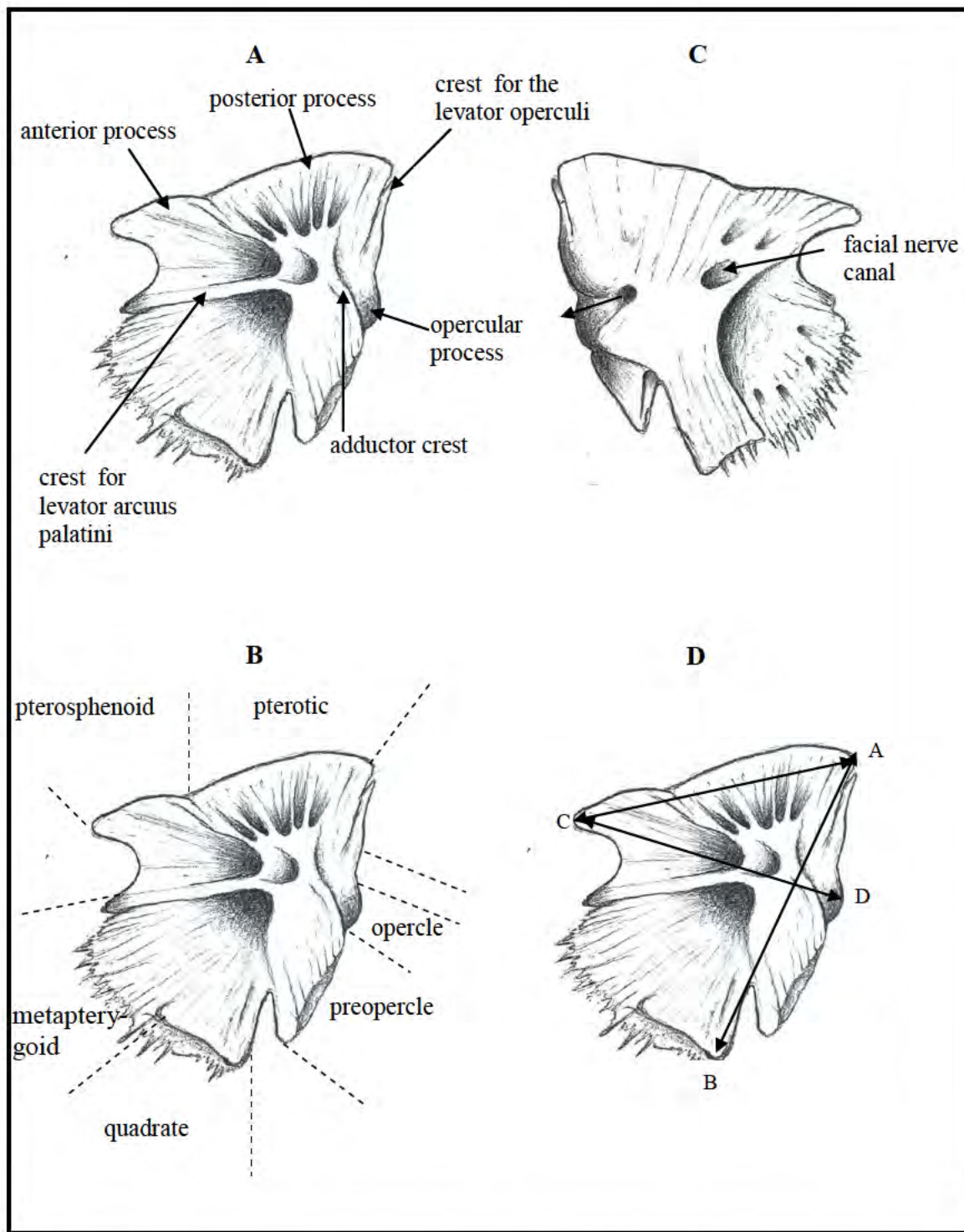

Figure 17. **Hyomandibular**. **A.** Lateral view. **B.** Mesial view. **C.** Articulations. **D.** Dimensions: AB. Height. AC. Dorsal margin length. CD. Width. NSMNH# 88122. Dash lines indicate a ventral connection.

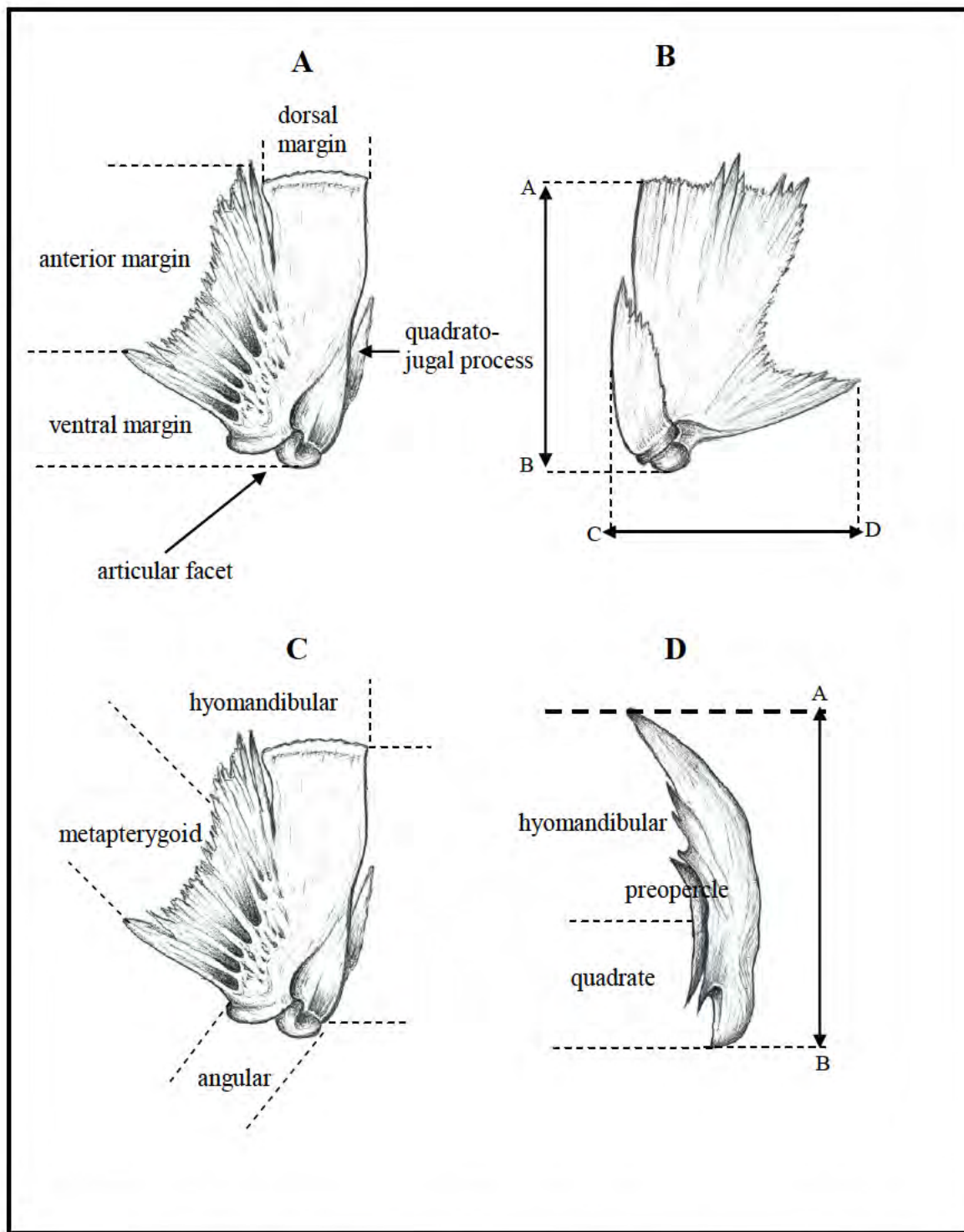

Figure 18. **Quadrate**. **A**. Lateral view. **B**. Mesial view. Dimensions: AB. Height. CD. Width. **C**. Articulations. **D**. **Preopercle**. Lateral view. Articulations and dimension: AB. Height. NSMNH #88122



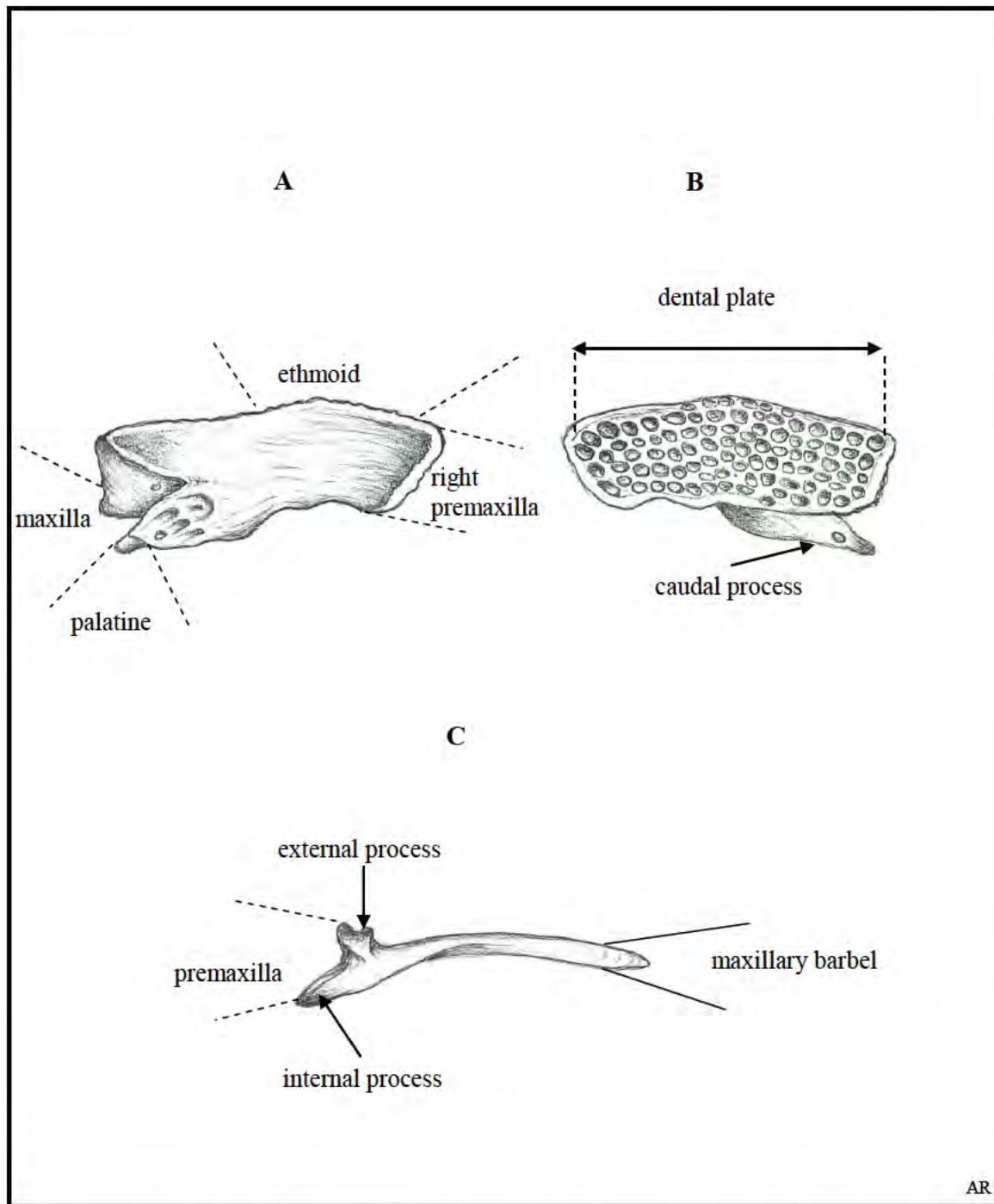

Figure 19. **Premaxilla**. **A**. Dorsal view. **B**. Ventral view. Dimension: AB. Length. **C**. **Maxilla**. Articulations. NSMNH #88122

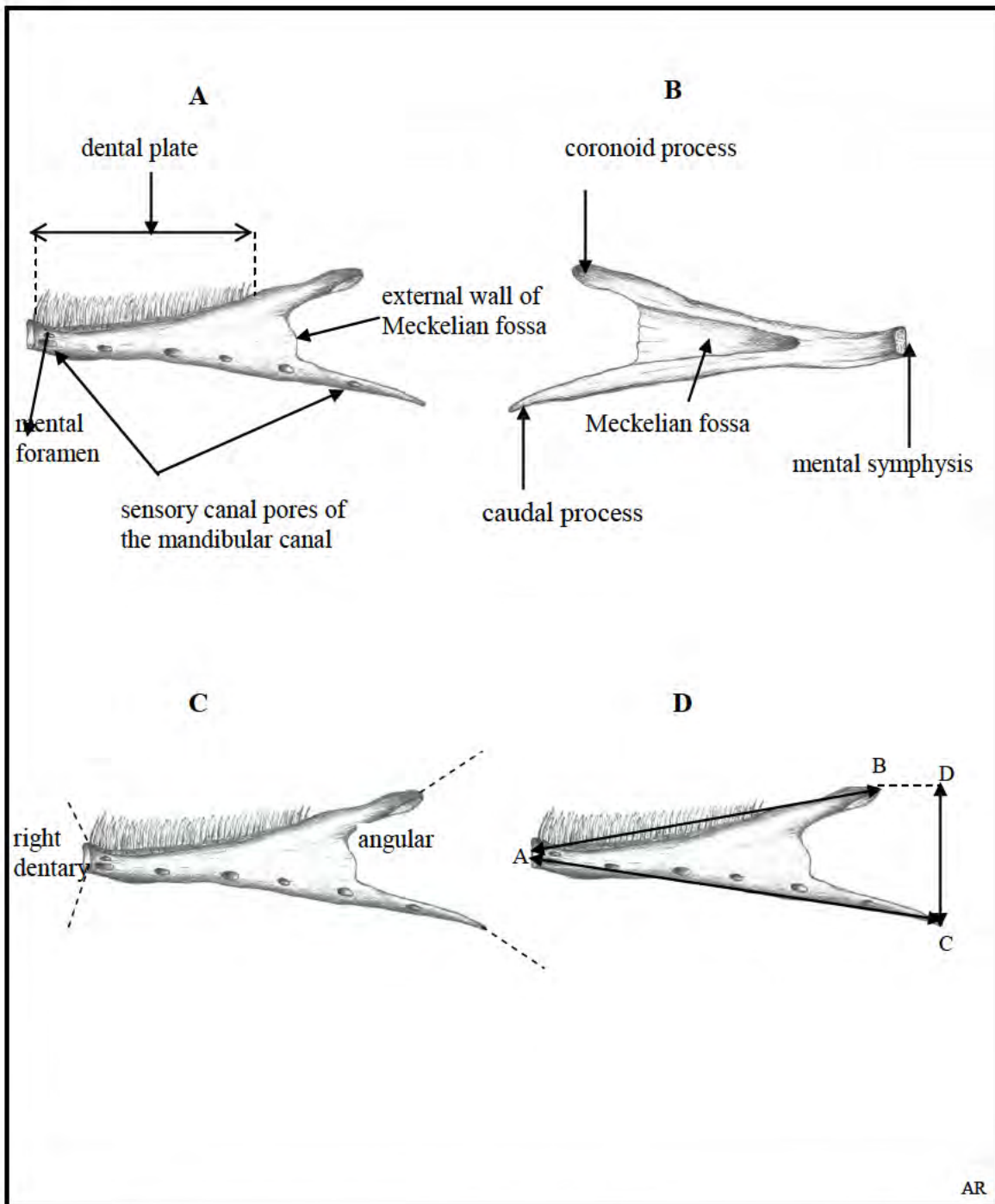

Figure 20. **Dentary**. **A**. Lateral view. **B**. Mesial view. **C**. Articulations. **D**. Dimensions: AB. Dorsal margin length. AC. Ventral margin length. CD. Height. NSMNH #88122.

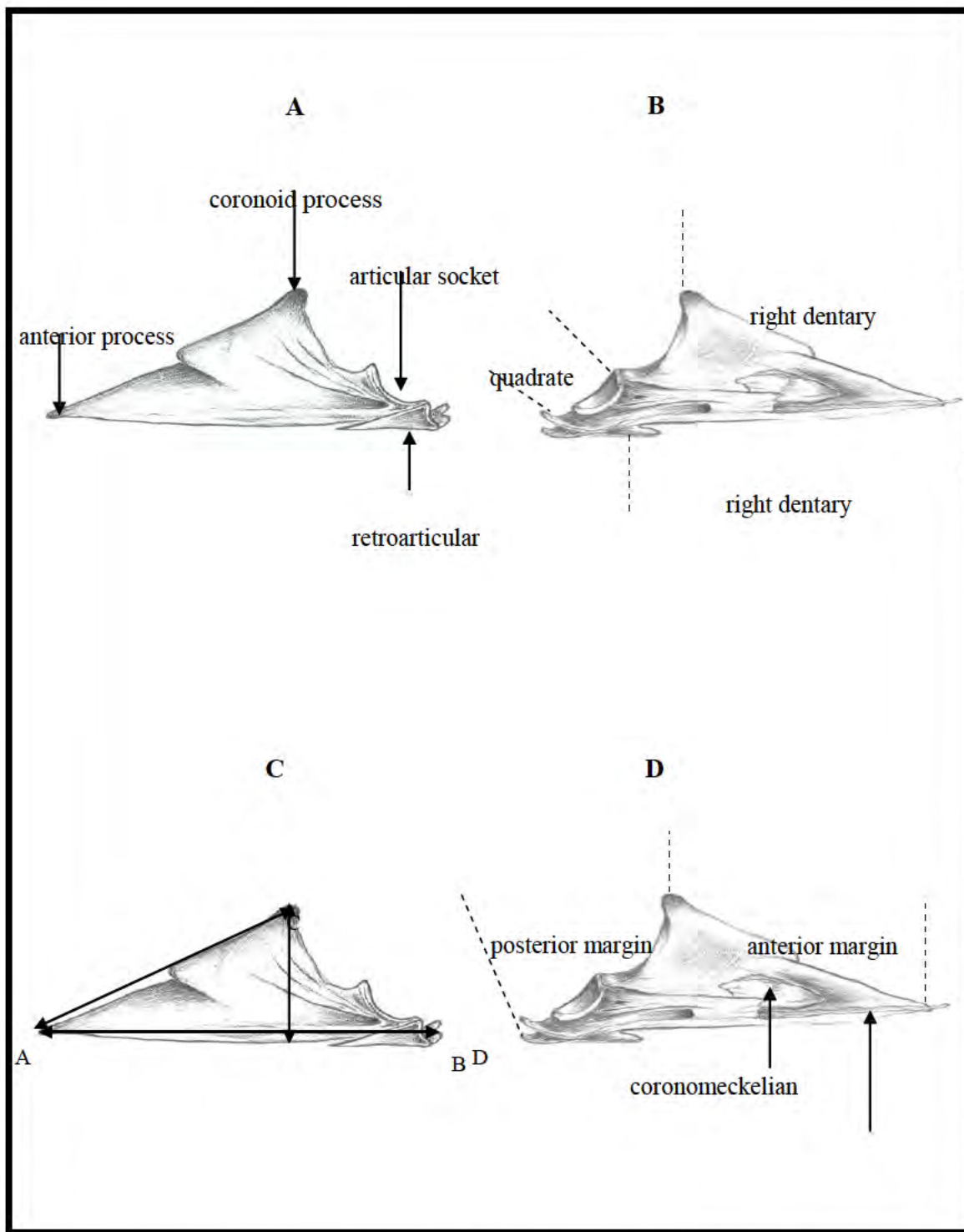

Figure 21. **Angular** A. Lateral view. B. Mesial view. Articulations. C. Dimensions: AB. Length. AC. Anterior margin length. CD. Height. D. **Angular** and **Coronomeckelian**. Mesial view. NSMNH #87922.

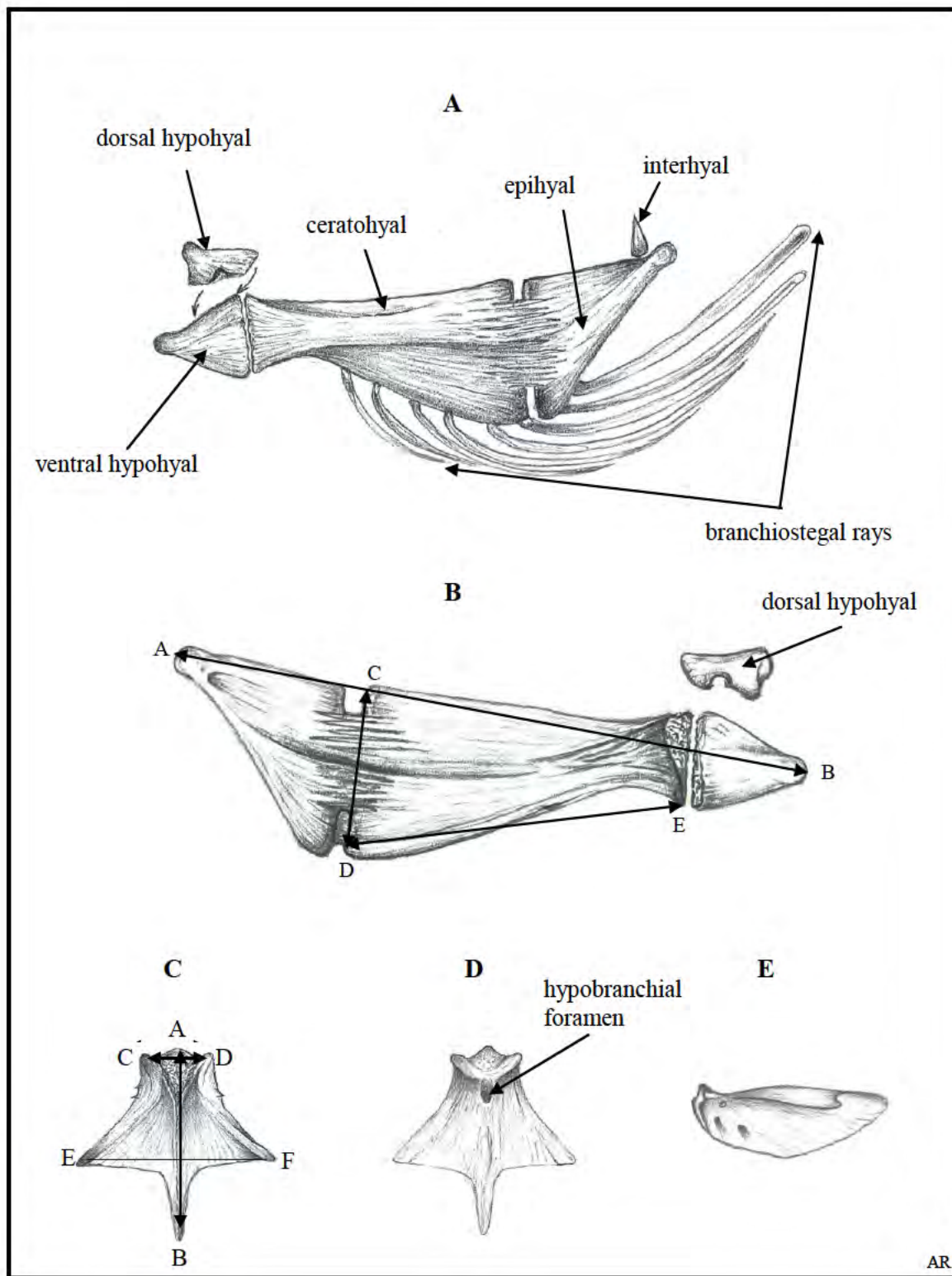

Figure 22. **Hyoid arch and Branchiostegal rays.** **A.** Lateral view. **B.** Mesial view. Dimensions: AB. Hyoid arch length. CD. Ceratohyal posterior margin height. DE. Ceratohyal ventral margin length. NSMNH #88122. **Urohyal.** **C.** Dorsal view. Dimensions: AB. Length. CD. Anterior width. EF. Posterior width. **D.** Ventral view. **E.** Lateral view. NSMNH#87922.

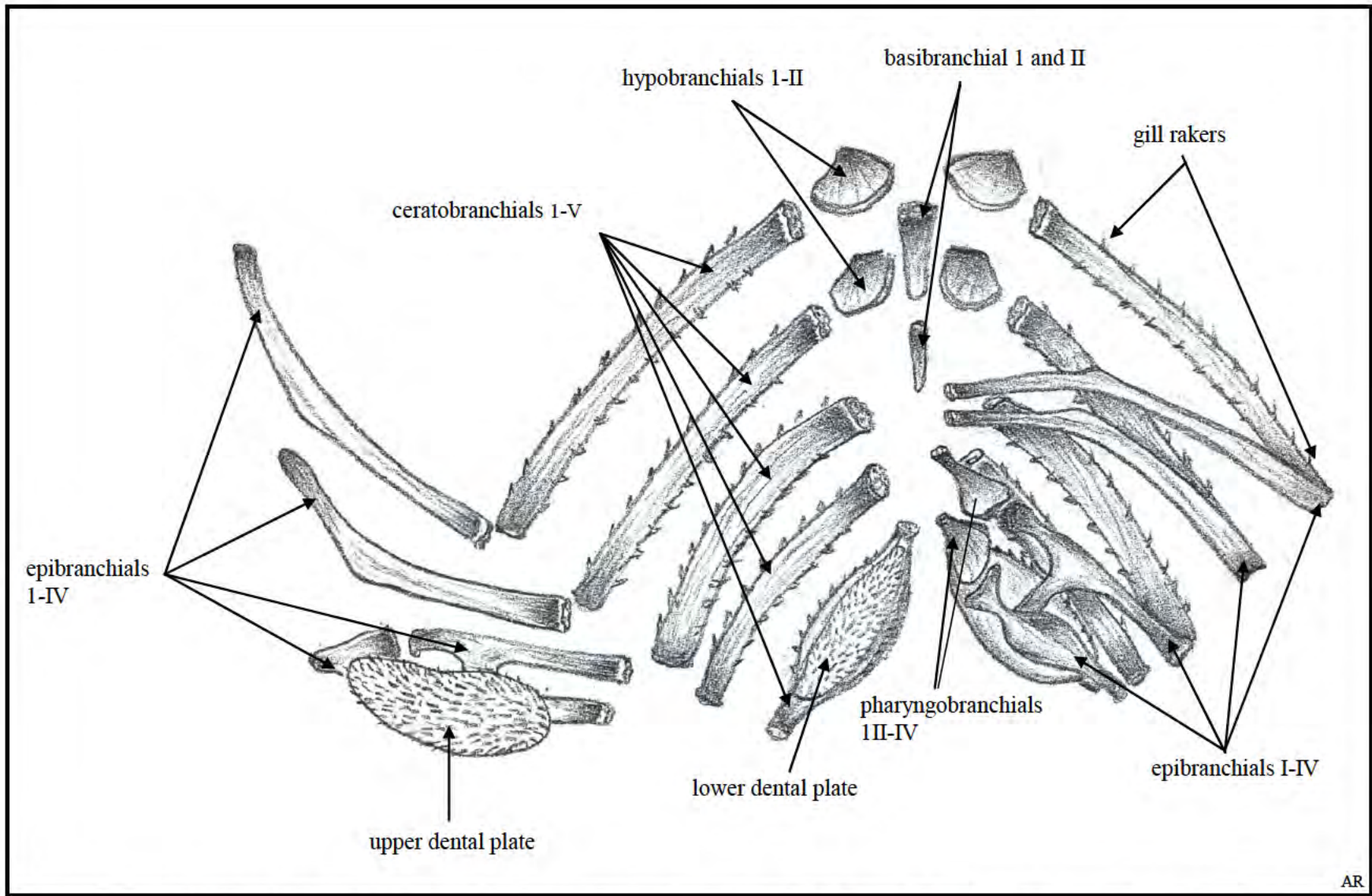

Figure 23. **Branchial arches.** Right side with the bones in natural position. Left side with hypobranchials and ceratobranchials in dorsal view. Epibranchials in ventral view (pharyngobranchials omitted). NSMNH#87825.

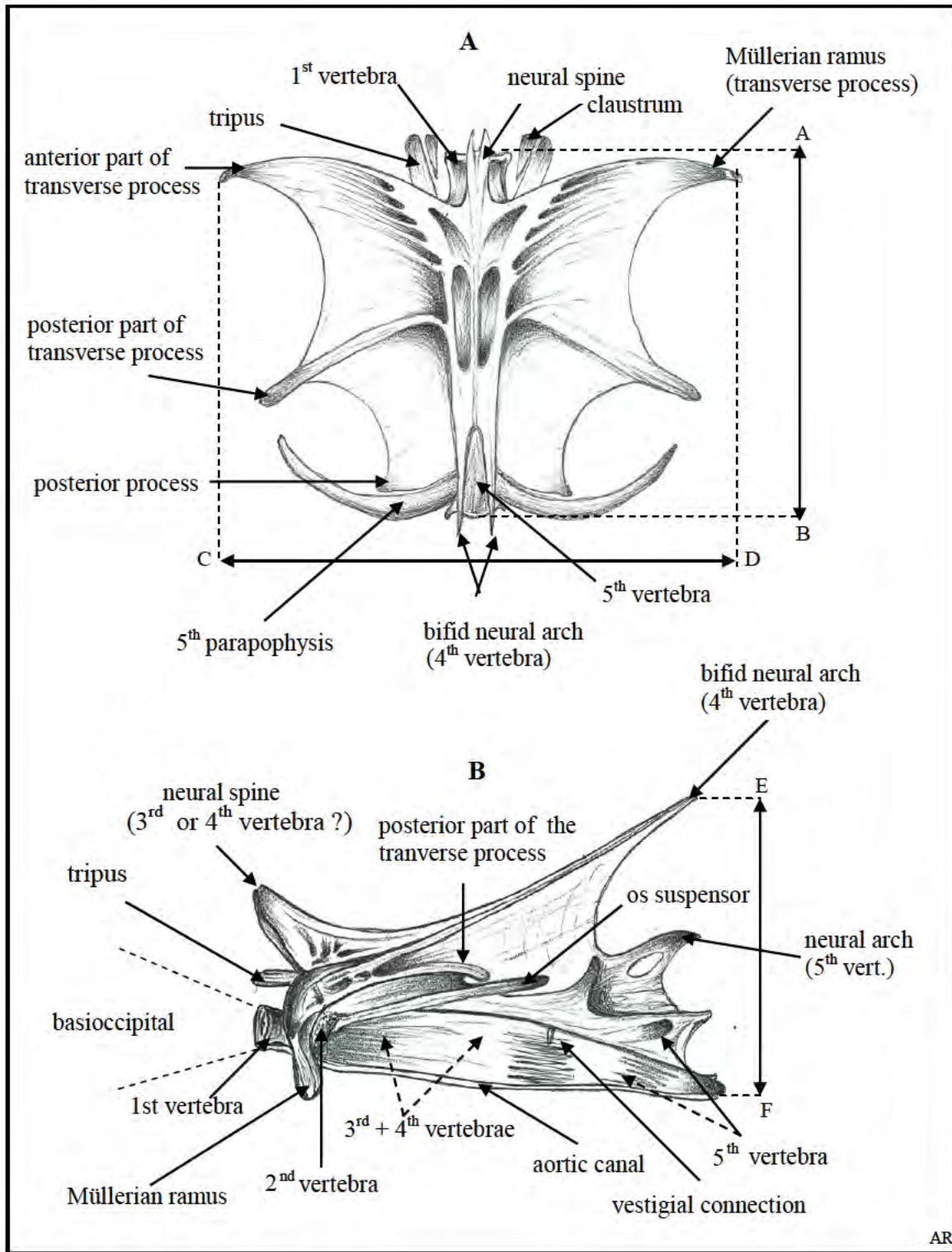

Fig. 24. **Weberian Apparatus**. **A**. Dorsal view. Dimensions: AB. Length. CD. Width. **B**. Lateral view. EF. Height. NSMNH #88122. The dash lines indicate the three vertebrae covered by the lateral bony plates.

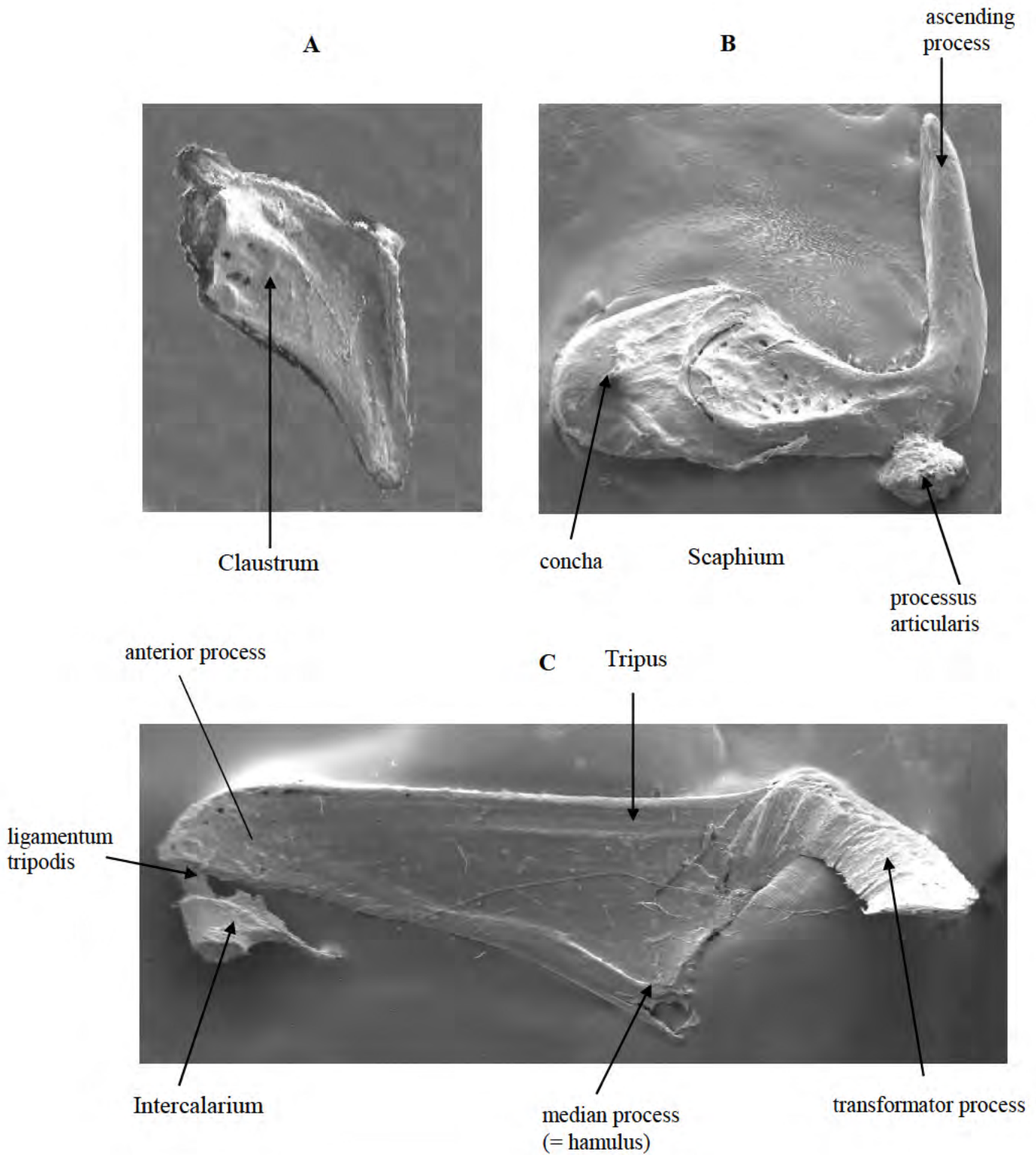

Fig. 25. Weberian ossicles. **A. Clastrum.** Lateral view. **B. Scaphium.** Lateral view. **C. Intercalarium and Tripus.** Ventral view. NSMNH #87479.

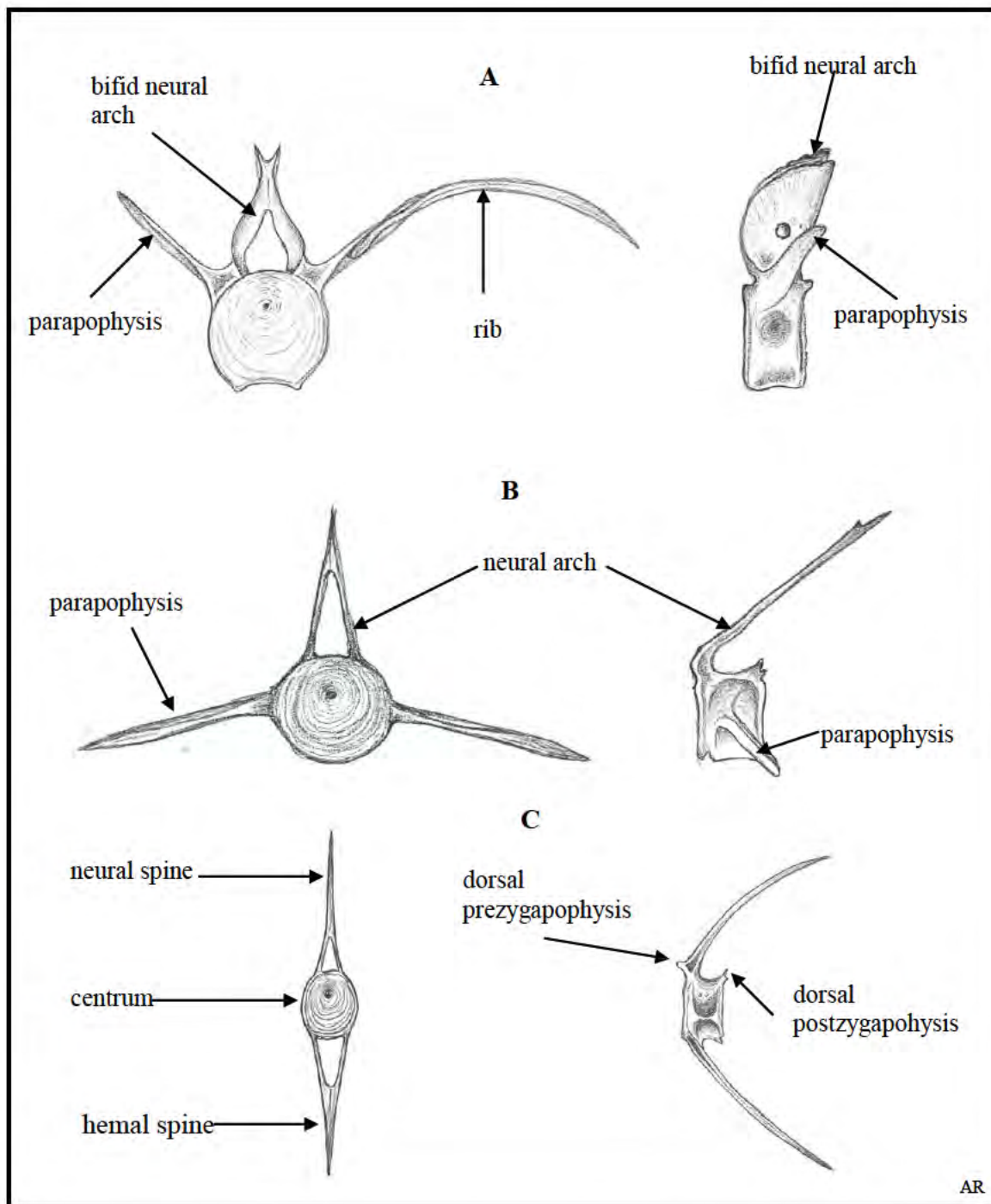

Figure 26. **A.** Sixth (first autonomous) precaudal vertebra. **B.** 11<sup>th</sup> precaudal vertebra. **C.** First caudal vertebra. Left column illustrations in frontal view. Right column illustrations in lateral view. NSMNH#88122.



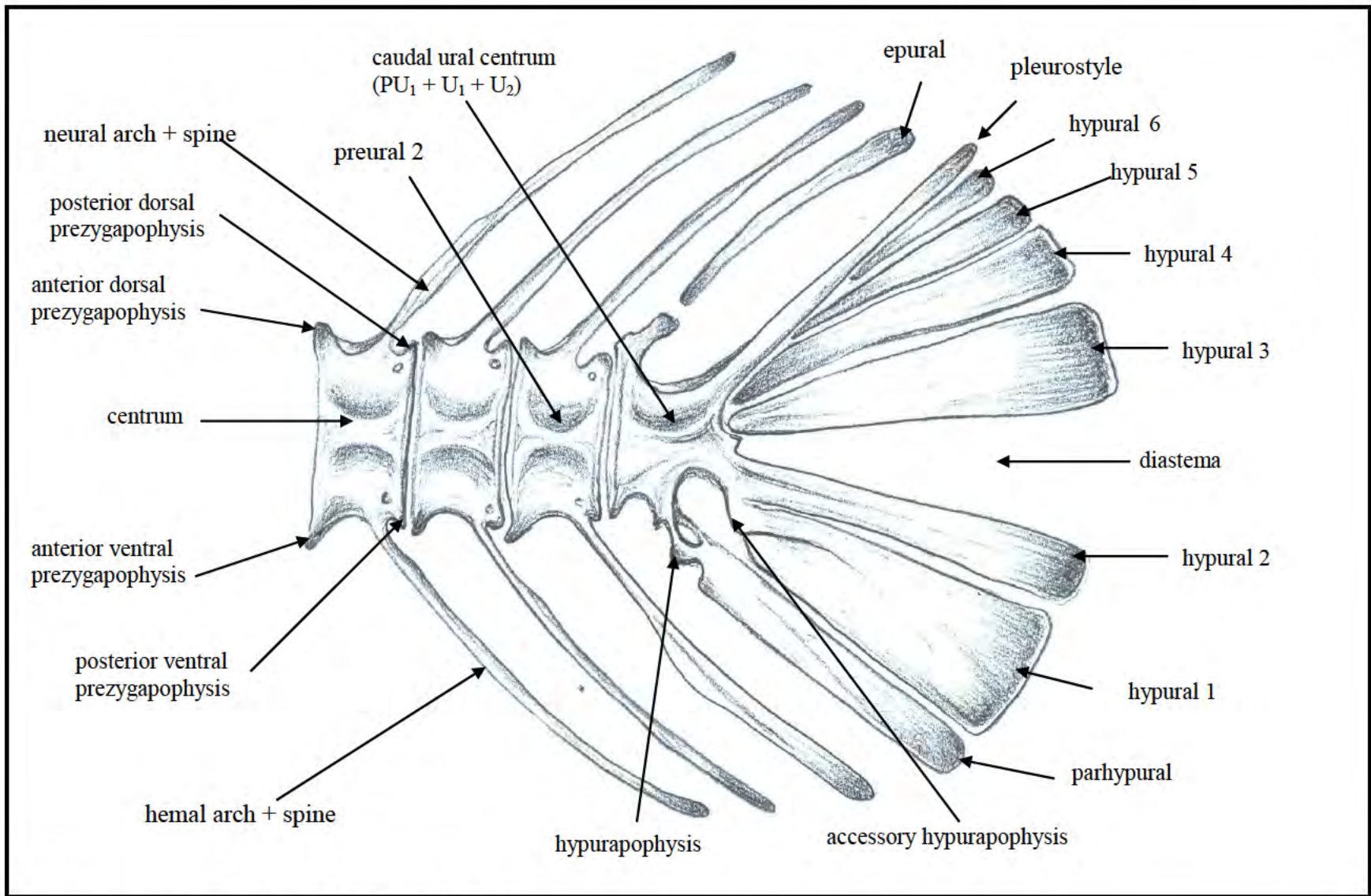

Figure 27. **Caudal skeleton.**NSMNH#88122.

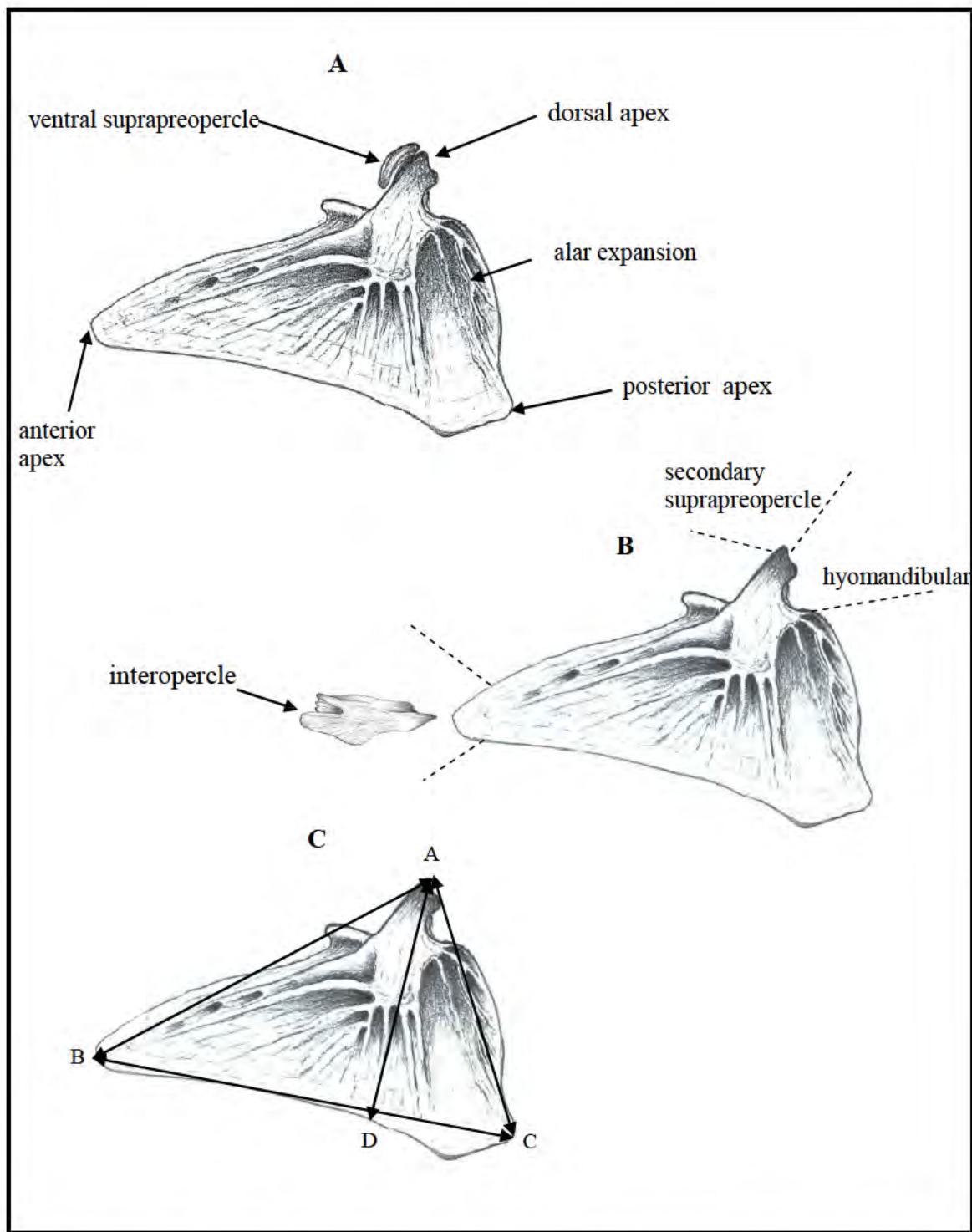

Figure 28. **Opercle**. **A**. Lateral view. **B**. Interopercle. Articulations. **C**. Dimensions: AB. Anterior margin length. AC. Dorsal margin length. BC. Ventral margin length. AD. Height. NSMNH# 88122.

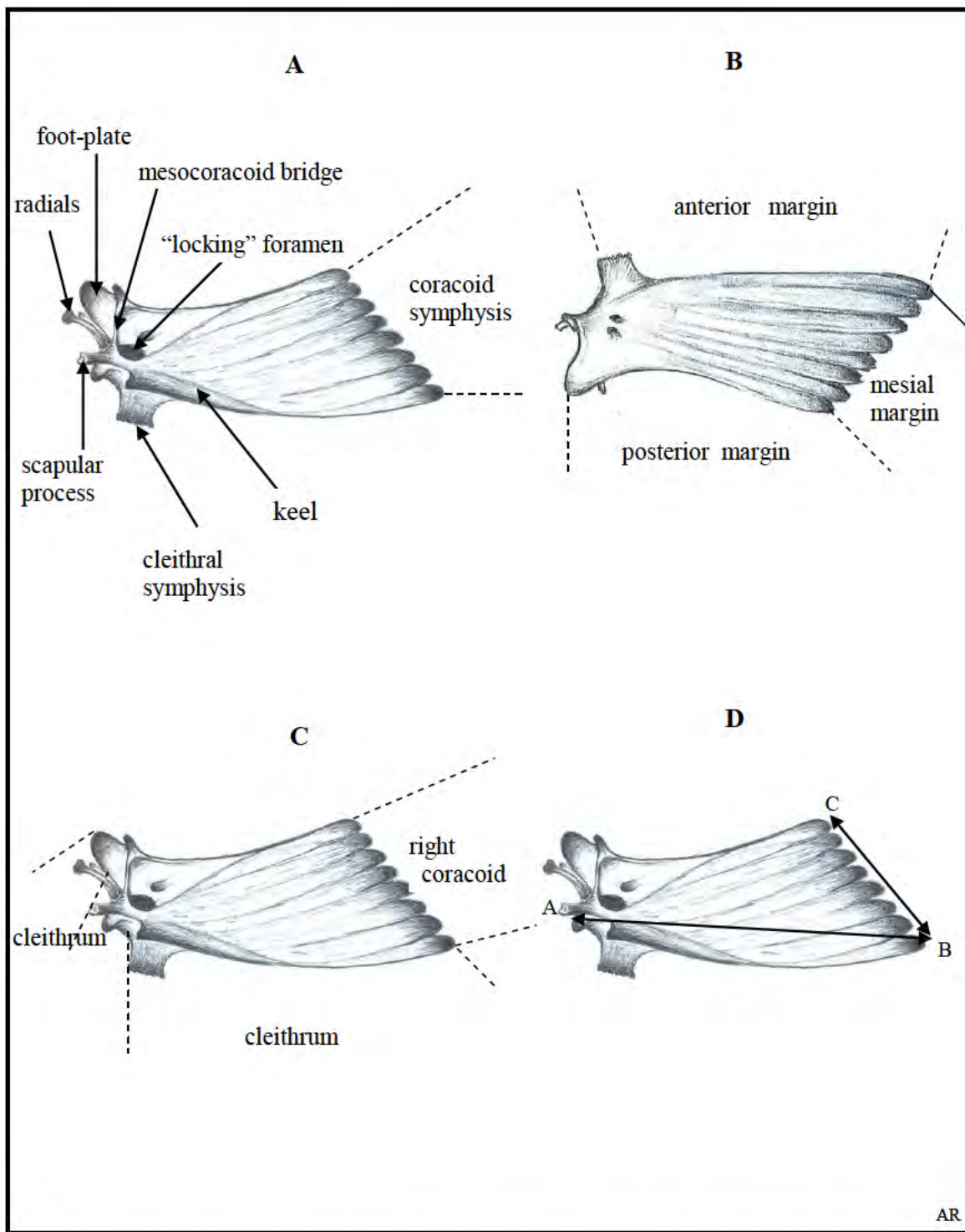

Figure 29. **Coracoid and Radials.** **A.** Ventral view of the bone lying flat. **B.** Dorsal view. **C.** Articulations. **D.** Dimensions: AB. Length. CB. Coracoid symphysis length. #NSMNH 88122.

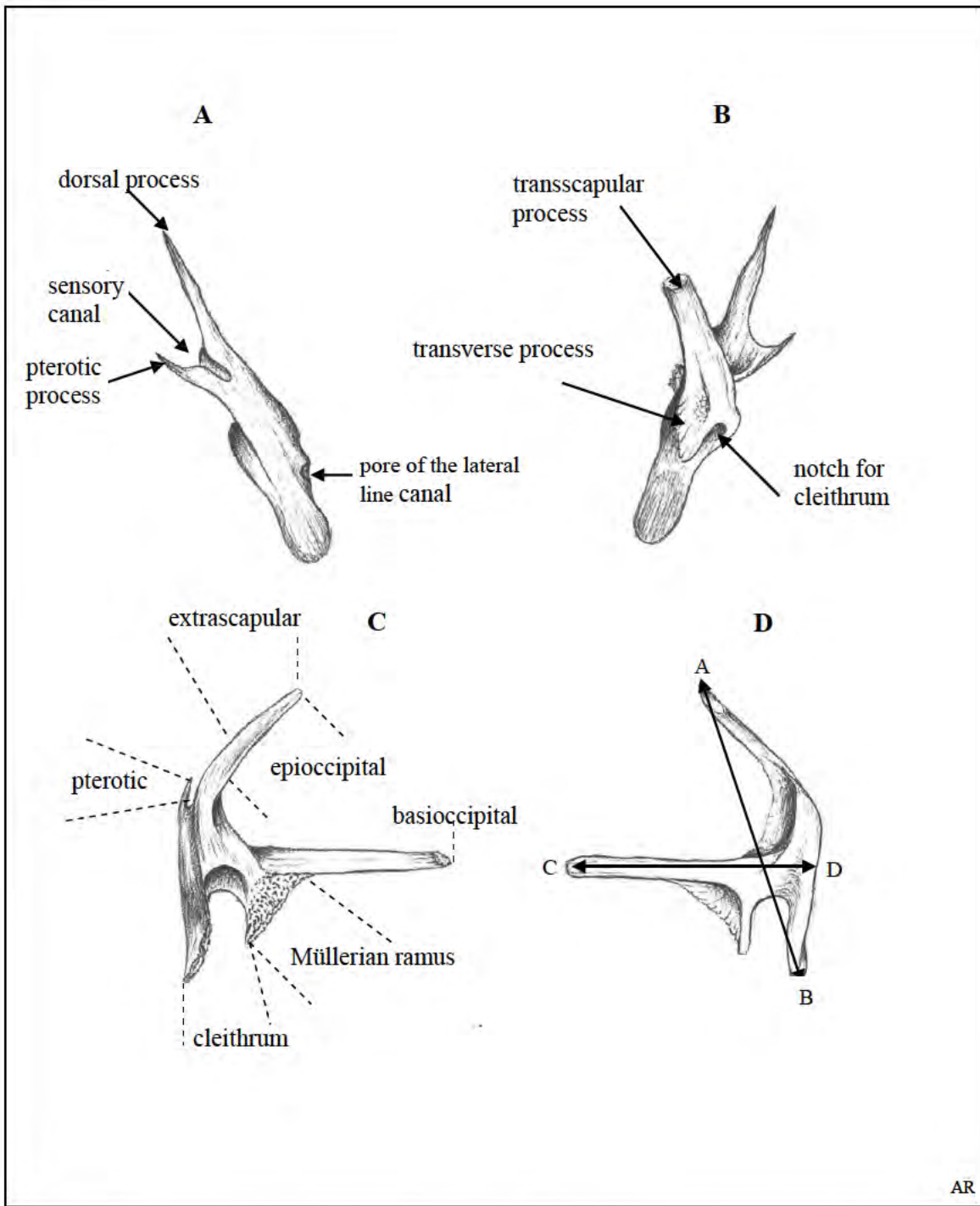

Fig. 30. **Posttemporal** A. Dorsolateral view. B. Dorsomesial view. C. Articulations. D. Dimensions: AB. Height. CD. Width. NSMNH #87919.

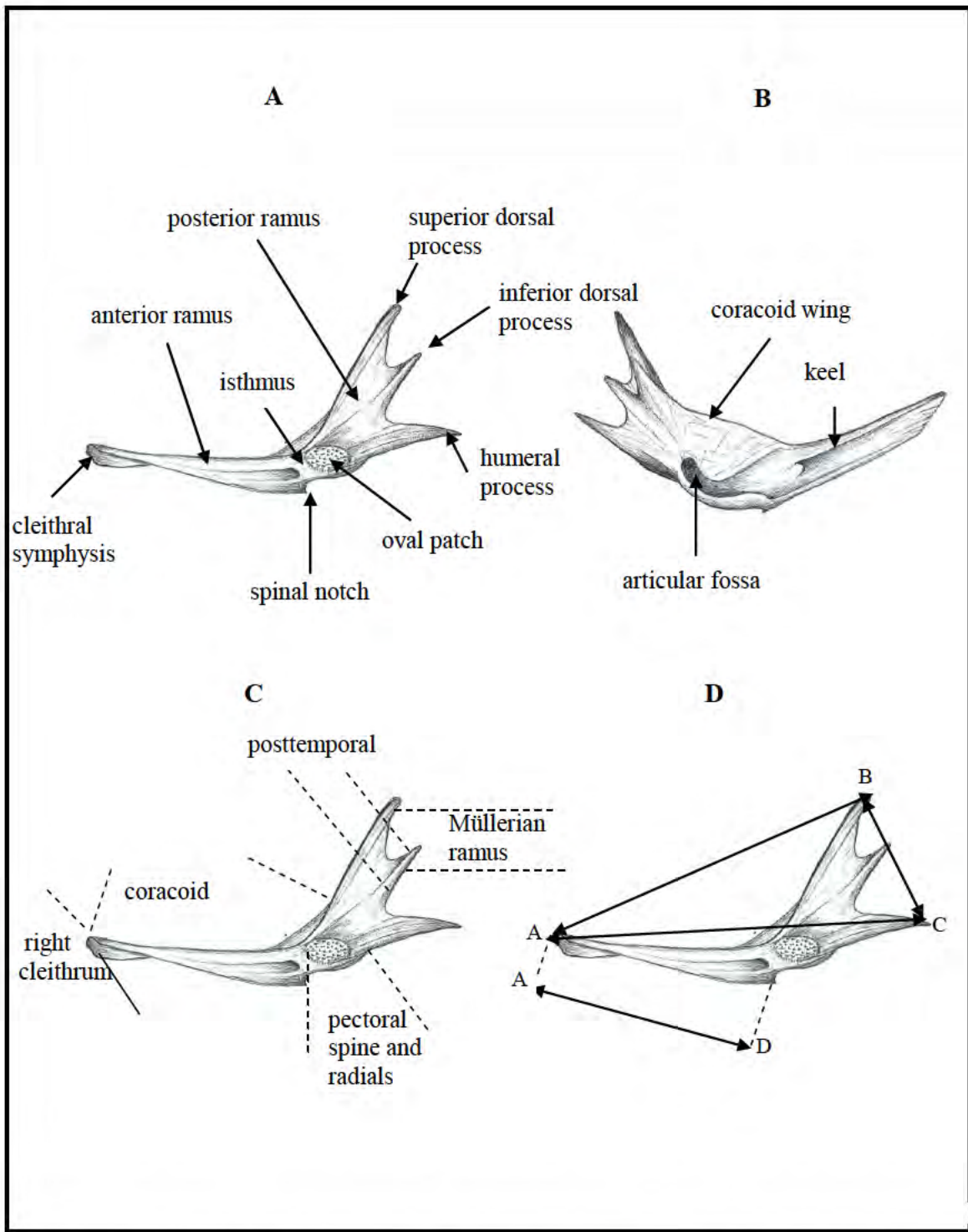

Figure 31. **Cleithrum.** **A.** Lateral view. **B.** Mesial view, bone lying flat. **C.** Articulations. **D.** Dimensions: AB. Chordal length. AC. Length. AD. Ventral limb length. BC. Spread of the processes. NSMNH # 87473. The dash lines refer to a ventral connection.

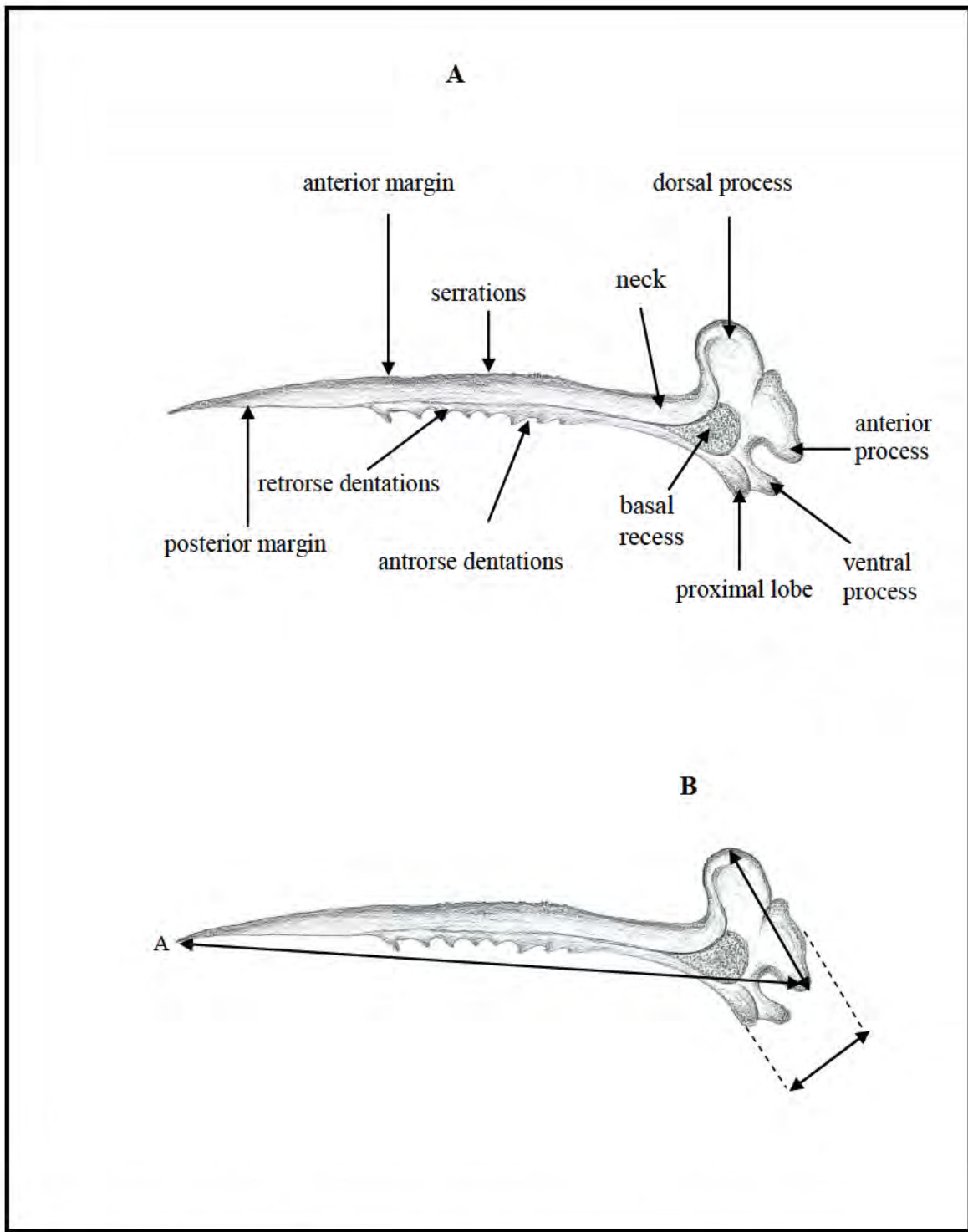

Figure 32. **Pectoral spine.** **A.** Dorsal view. **B.** Dimensions: AB. Spine length. BC. Head length. DE. Head width. NHMNH# 88122.

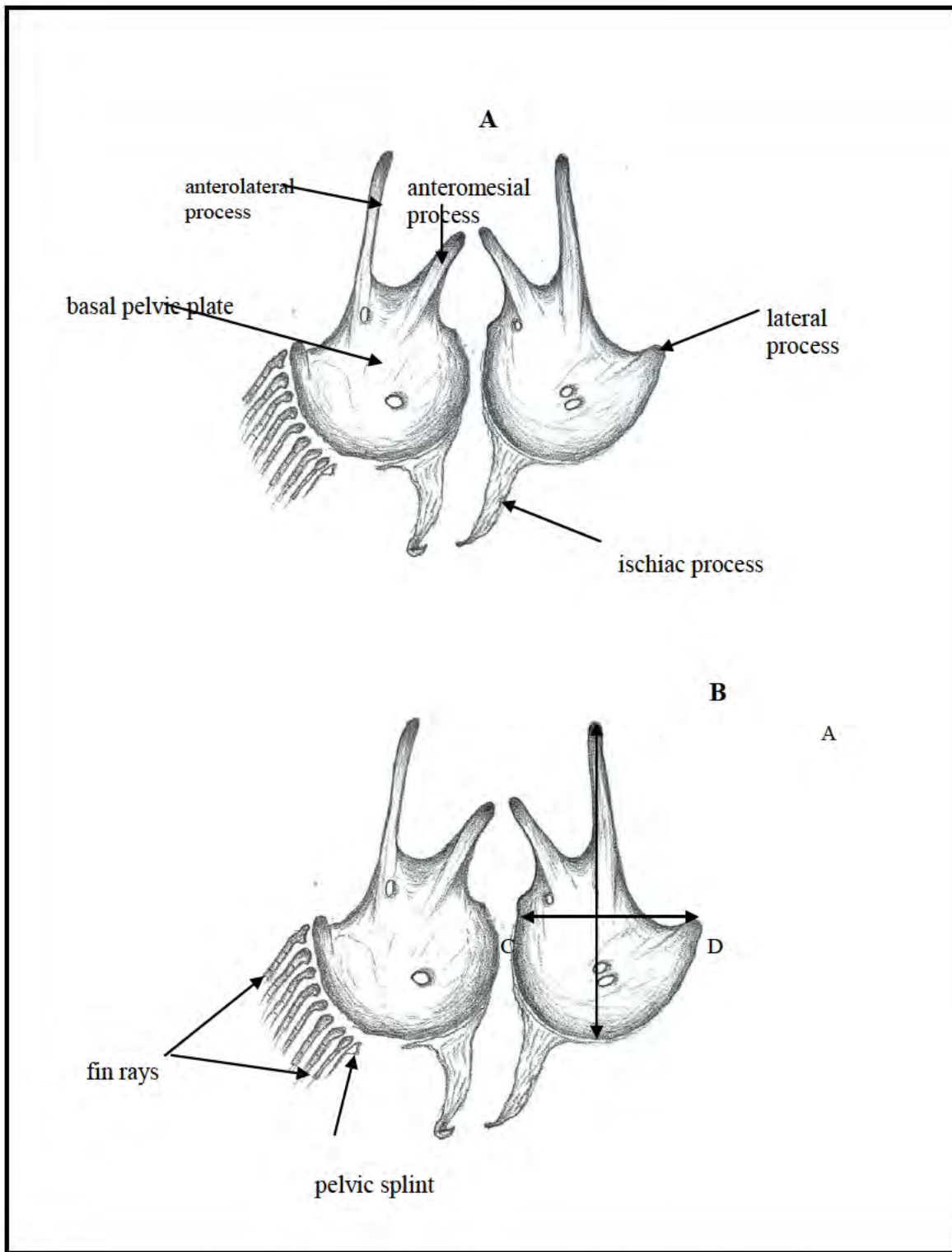

Figure 33. **Pelvic girdle and pelvic fin rays.** **A.** Dorsal view. **B.** Ventral view. Dimensions. AB. Length. CD. Width. NSMNH#87480.

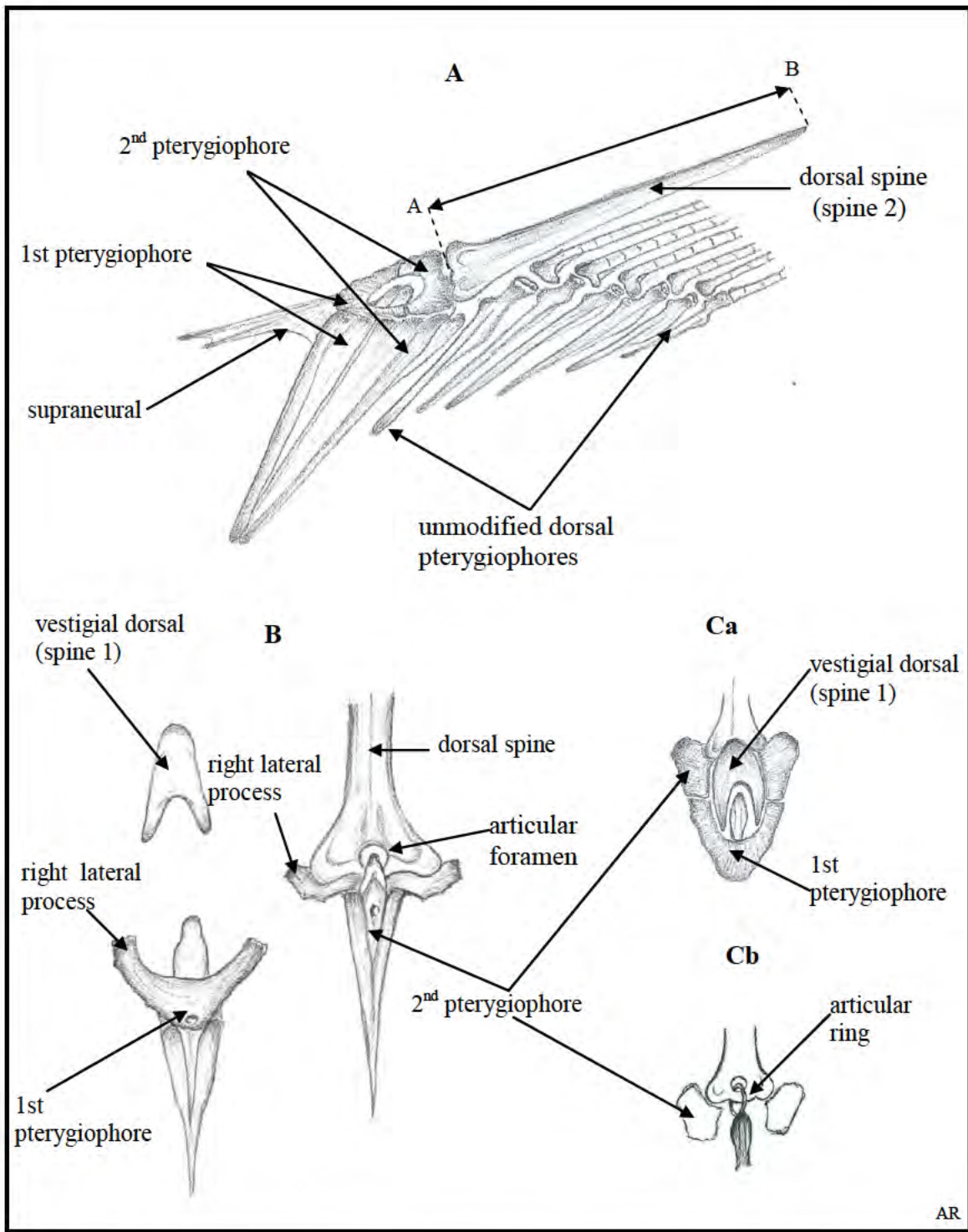

Figure 34. **Dorsal spine and dorsal pterygiophores.** **A.** Dorsolateral view. **AB.** Length. **B.** Frontal view. Disarticulated elements. **Ca** and **Cb** Dorsal view. Elements *in situ*. NSMNH#88122.



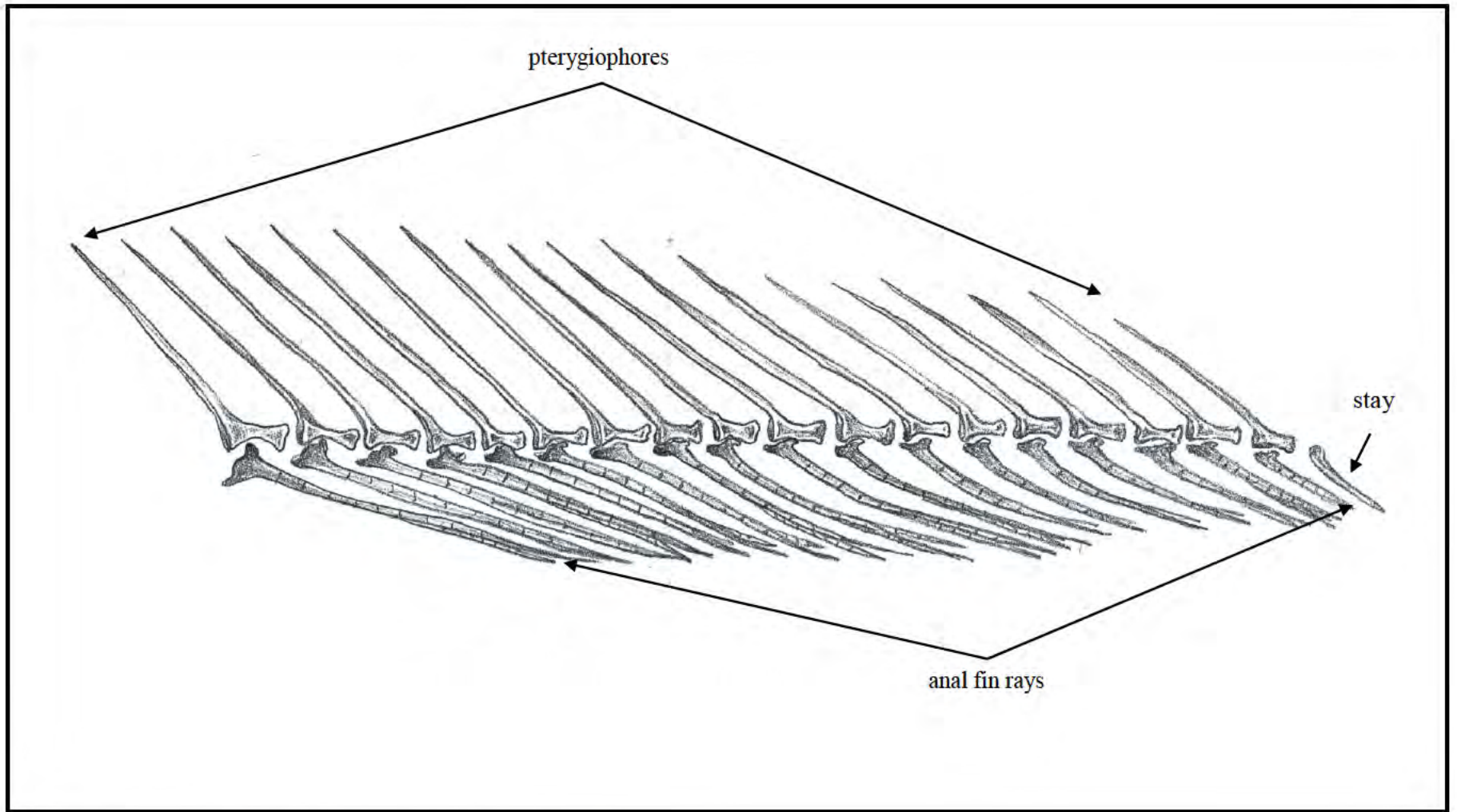

Figure 35. **Anal fin pterygiophores** and **fin rays**. NSMNH#88122.

## IV.II APPENDIX II

### BIOMETRIC TABLES

All measurements were taken as the straight line between two points using the calipers and not following the body's curvature. All measurements correspond to the left bone for paired bones. In a few cases, when the left bone was missing or broken, the right side bone was measured. No test was made to see whether there was a significant difference between both sides, but experience with other fish species and a few checks with the material at hand indicated otherwise. A capital "R" on the right side of a table indicates that the right bone has been measured.

For the interpretation of letter combinations (TFL, SFL, AB, AC, CD, etc.), please, refer to the description and illustration sections of each bone.

The total fish length (TFL) was measured from the snout to the end of each caudal lobe with an approximation of 0.1 mm. The average of both values was recorded as the total length. The standard length (SFL) was measured from the snout up to the prominence at the end of the last full vertebra, as felt with the fingers.

Total fish length (TFL), standard fish length (SFL), and total fish weight (TFW) appear in all tables, to save the reader time and inconvenience. The correlation between TFL and SFL is very high ( $r = 0.996$ ;  $N = 24$ . Specimen #87927 is included in this number, but it was not used for other measurements, because it has been stored as whole articulated skeleton). Researchers using the standard length in their work can easily convert the total length to standard length by using the formula relating both.

Total fish weight was not related to any other dimension, because of the rather small size of most specimens, but it is offered in every table. When needed, it will be easy to find the relationship between -TFL and TFW- and calculate the values of "a", "b" and "r" with the data available in the tables using logarithms.

The statistical relationship between each dimension and the total fish length (TFL) is given using the regression coefficients, "a" and "b" and the correlation coefficient "r." Sometimes a poor correlation is published, pending its confirmation or improvement in future works.

Due to the small size of the two individual samples from St. Mary's River and Medway River, no other statistics were calculated.

**Table 1. Neurocranium - length dimensions and measurements**

| NSM#  | TFL   | SFL   | AF   | F1    | F2   | OO'  | AB   | AC   | AD   | AE   | TFW    |
|-------|-------|-------|------|-------|------|------|------|------|------|------|--------|
| 87471 | 151.0 | 123.5 | .    | 5.5   | .    | .    | 8.5  | 15.7 | .    | .    | 42.78  |
| 87472 | 143.9 | 116.1 | .    | .     | .    | .    | .    | .    | .    | .    | 34.52  |
| 87473 | 156.0 | 128.2 | .    | .     | .    | .    | .    | .    | .    | .    | 42.50  |
| 87474 | 145.5 | 119.0 | .    | .     | .    | .    | .    | .    | .    | .    | 38.50  |
| 87475 | 135.5 | 109.5 | 32.8 | 7.9   | 10.6 | 6.8  | 8.6  | 17.2 | 26.8 | 28.5 | 29.46  |
| 87477 | 142.0 | 115.2 | 34.6 | 6.0   | 11.9 | 6.3  | 9.1  | 20.3 | 29.3 | 31.1 | 30.94  |
| 87479 | 152.0 | 122.7 | 37.9 | 7.9   | 12.4 | 8.0  | 9.7  | 21.0 | 31.1 | 32.5 | 40.01  |
| 87480 | 155.9 | 128.8 | 38.6 | 6.4   | 14.4 | 7.1  | 10.0 | 21.6 | 31.4 | 33.3 | 44.40  |
| 87481 | 153.5 | 125.4 | 36.8 | 7.9   | 12.4 | 6.3  | 9.7  | 20.6 | 30.6 | 32.4 | 38.30  |
| 87482 | 149.8 | 122.9 | 38.2 | 8.1   | 12.3 | 7.0  | 11.0 | 21.3 | 32.1 | 33.0 | 43.71  |
| 87919 | 161.5 | 130.0 | .    | .     | .    | .    | .    | .    | .    | .    | 38.06  |
| 87920 | 132.7 | 106.4 | .    | .     | .    | .    | .    | .    | .    | .    | 21.01  |
| 87921 | 128.2 | 104.5 | .    | .     | .    | .    | .    | .    | .    | .    | 19.99  |
| 87922 | 177.8 | 146.3 | 24.2 | 9.6   | 13.1 | 7.6  | 11.4 | 24.4 | 41.6 | 38.8 | 61.01  |
| 87923 | 162.6 | 132.6 | .    | .     | .    | .    | .    | .    | .    | .    | 43.53  |
| 87924 | 168.0 | 140.3 | 41.6 | 7.7   | 13.5 | 7.8  | 11.6 | 22.5 | 33.7 | 35.8 | 53.11  |
| 87925 | 167.1 | 136.5 | 47.5 | 10.3  | 15.3 | .    | 13   | 26.2 | 40   | 42.4 | 47.62  |
| 87926 | 174.4 | 147.4 | 42.4 | 8.0   | 13.1 | 7.4  | 11.1 | 23.1 | 35.3 | 36.8 | 54.28  |
| 87824 | 192.2 | 152.9 | 47.2 | 8.4   | 15.1 | 8.7  | 11.4 | 25.9 | 37.1 | 40.8 | 73.40  |
| 87825 | 181.4 | 148.2 | 47.7 | 9.0   | 14.7 | 9.4  | 15.3 | 27.6 | 40.0 | 42.7 | 66.05  |
| 88122 | 274.3 | 224.4 | 66.0 | 8.4   | 23.0 | 12.0 | 27.6 | 35.2 | 55.9 | 58.5 | 251.78 |
| 88123 | 250.0 | 205.9 | 55.5 | .     | 18.8 | 8.4  | 19.8 | 32.8 | 47.8 | 50.7 | 206.62 |
| 11270 | 187.0 | 162.0 | 42.4 | 7.3   | 15.1 | 7.3  | 12.1 | 25.3 | 40.0 | 42.7 | 79.95  |
| #1    | 295.0 | .     | .    | .     | .    | .    | .    | .    | .    | .    | .      |
| #2    | 270.0 | .     | 68.6 | 12.00 | .    | .    | 20.2 | 40.2 | 59.4 | 64.4 | .      |

| VARIABLES |         | REGRESION EQUATIONS | CORRELATION COEFFICIENT | N  |
|-----------|---------|---------------------|-------------------------|----|
| Y         | X       |                     |                         |    |
| 1.        | TFL SFL | Y = 1.19 X + 4.32   | 0.996                   | 23 |
| 2.        | TFL AF  | Y = 3.30 X + 38.26  | 0.878                   | 16 |
| 3.        | TFL F1  | Y = 14.92 X + 55.37 | 0.588                   | 16 |
| 4.        | TFL F2  | Y = 11.91 X + 6.13  | 0.954                   | 15 |
| 5.        | TFL OO' | Y = 22.12 X + 4.20  | 0.823                   | 14 |
| 6.        | TFL AB  | Y = 7.90 X + 79.05  | 0.937                   | 16 |
| 7.        | TFL AC  | Y = 6.43 X + 22.12  | 0.948                   | 16 |
| 8.        | TFL AD  | Y = 4.50 X + 11.00  | 0.961                   | 16 |
| 9.        | TFL AE  | Y = 4.20 X + 14.13  | 0.966                   | 16 |

**Evaluation:** AC, AC, AD, and AE are reliable dimensions because their reference points are strongly calcified and well defined. AF is not so valuable because of the variability of the supraoccipital spine. The spine has two frequent drawbacks: the lack of alignment with the neurocranium axis and the variability of its length. See Fig. 4A.

**Table 2. Neurocranium - width dimensions and measurements**

| NSM#  | TFL   | SFL   | W    | W2   | W3   | W4   | W5   | VL   | VH   | TFW    |
|-------|-------|-------|------|------|------|------|------|------|------|--------|
| 87471 | 151.0 | 123.5 | 7.1  | 15.2 | .    | .    | .    | .    | .    | 42.78  |
| 87472 | 143.9 | 116.1 | 7.3  | .    | .    | .    | .    | .    | .    | 34.52  |
| 87473 | 156.0 | 128.2 | 7.8  | .    | .    | .    | .    | .    | .    | 42.50  |
| 87474 | 145.5 | 119.0 | 7.3  | .    | .    | .    | .    | .    | .    | 38.50  |
| 87475 | 135.5 | 109.5 | 6.8  | 14.1 | 10.5 | 15.5 | 16.1 | 28.4 | 7.8  | 29.46  |
| 87477 | 142.0 | 115.2 | 7.5  | 15.2 | 11.0 | 16.8 | 13.0 | 30.7 | 8.6  | 30.94  |
| 87479 | 152.0 | 122.7 | 7.5  | 16.4 | 12.0 | 17.8 | 13.0 | 32.4 | 9.2  | 40.01  |
| 87480 | 155.9 | 128.8 | 8.1  | 16.4 | 12.0 | 18.0 | 13.4 | 33.6 | 9.2  | 44.40  |
| 87481 | 153.5 | 125.4 | 7.3  | 15.5 | 12.0 | 18.2 | 12.4 | 32.3 | 9.1  | 38.30  |
| 87482 | 149.8 | 122.9 | 7.5  | 16.2 | 12.0 | 18.3 | 13.2 | 32.5 | 8.7  | 43.71  |
| 87919 | 161.5 | 130.0 | 8.6  | .    | .    | .    | .    | .    | .    | 38.06  |
| 87920 | 132.7 | 106.4 | 6.4  | .    | .    | .    | .    | .    | .    | 21.01  |
| 87921 | 128.2 | 104.5 | 5.7  | .    | .    | .    | .    | .    | .    | 19.99  |
| 87922 | 177.8 | 146.3 | 9.1  | 19.1 | 13   | 13.4 | 20.9 | .    | 11.0 | 61.01  |
| 87923 | 162.6 | 132.6 | 8.1  | .    | .    | .    | .    | .    | .    | 43.53  |
| 87924 | 168.0 | 140.3 | 8.8  | 18.3 | 13.0 | 18.8 | 15.4 | 35.9 | 10.0 | 53.41  |
| 87925 | 167.1 | 136.5 | 11.3 |      | 14.3 | 22.3 | 22.0 | 42.0 | 11.3 | 47.62  |
| 87926 | 174.4 | 147.4 | 8.8  | 18.4 | 14.0 | 19.5 | 14.4 | 36.8 | 10.0 | 54.28  |
| 87824 | 192.2 | 152.9 | 10.1 | 21.4 | 14.0 | 21.8 | 16.7 | 40.8 | 11.0 | 73.40  |
| 87825 | 181.4 | 148.2 | 8.3  | 20.5 | 14.0 | 22.4 | 16.9 | 42.1 | 11.0 | 66.05  |
| 88122 | 274.3 | 224.4 | 15.8 | 30.9 | 20.0 | 32.4 | 22.5 | 57.2 | 17.0 | 251.78 |
| 88123 | 250.0 | 205.9 | 13.1 | 25.1 | 18.0 | 27.6 | .    | .    | .    | 206.62 |
| 11270 | 187.0 | 162.0 | 9.4  | 20.2 | 14.0 | 20.4 | 15.4 | 37.1 | 11.0 | 79.95  |
| #1    | 295.0 | .     | .    | .    | .    | .    | .    | .    | .    | .      |
| #2    | 270.0 | .     | 16.6 | 32.0 | 18.3 | 31.2 | 25.1 | 62.3 | 18.0 | .      |

| VARIABLES |         | REGRESION           | CORRELATION |    |
|-----------|---------|---------------------|-------------|----|
| Y         | X       | EQUATIONS           | COEFFICIENT | N  |
| 1.        | TFL SFL | Y = 1.19 X + 4.32   | 0.996       | 23 |
| 2.        | TFL W1  | Y = 14.00 X + 46.40 | 0.962       | 24 |
| 3.        | TFL W2  | Y = 8.08 X + 23.17  | 0.985       | 16 |
| 4.        | TFL W3  | Y = 15.84 X - 36.75 | 0.979       | 16 |
| 5.        | TFL W4  | Y = 7.51 X + 26.16  | 0.919       | 16 |
| 6.        | TFL W5  | Y = 7.96 X + 45.85  | 0.777       | 16 |
| 7.        | TFL VL  | Y = 4.23 X + 14.32  | 0.969       | 14 |
| 8.        | TFL VH  | Y = 14.00 X + 26.73 | 0.984       | 15 |

**Evaluation:** All widths are reliable measurements because of the heavy calcification of the points selected. The low value of W5 is probably due to the difficulty in locating the end points of the epioccipital with the calipers. See Figs. 4A and 4B

**Table 3. Ethmoid - dimensions and measurements**

| NSM#  | TFL   | SFL   | AB   | CD   | TFW    |
|-------|-------|-------|------|------|--------|
| 87471 | 151.0 | 123.5 | 8.7  | 7.3  | 42.78  |
| 87472 | 143.9 | 116.1 | 8.4  | 7.1  | 34.52  |
| 87473 | 156.0 | 128.2 | 9.2  | 7.8  | 42.50  |
| 87474 | 145.5 | 119.0 | 8.6  | 7.3  | 38.50  |
| 87475 | 135.5 | 109.5 | .    | 6.8  | 29.46  |
| 87477 | 142.0 | 115.2 | 8.5  | 7.5  | 30.94  |
| 87479 | 152.0 | 122.7 | 9.3  | 7.5  | 40.01  |
| 87480 | 155.9 | 128.8 | 10.7 | 8.1  | 44.40  |
| 87481 | 153.5 | 125.4 | 9.6  | 7.3  | 38.30  |
| 87482 | 149.8 | 122.9 | 8.3  | 7.5  | 43.71  |
| 87919 | 161.5 | 130.0 | 9.6  | 8.6  | 38.06  |
| 87920 | 132.7 | 106.4 | 8.2  | 6.4  | 21.01  |
| 87921 | 128.2 | 104.5 | 6.9  | 5.7  | 19.99  |
| 87922 | 177.8 | 146.3 | 10.9 | 9.1  | 61.01  |
| 87923 | 162.6 | 132.6 | 9.6  | 8.1  | 43.53  |
| 87924 | 168.0 | 140.3 | 9.7  | 8.8  | 53.41  |
| 87925 | 167.1 | 136.5 | .    | 11.3 | 47.62  |
| 87926 | 174.4 | 147.4 | 10.6 | 8.8  | 54.28  |
| 87824 | 192.2 | 152.9 | 11.9 | 10.1 | 73.40  |
| 87825 | 181.4 | 148.2 | 9.6  | 8.3  | 66.05  |
| 88122 | 274.3 | 224.4 | 16.4 | 15.8 | 251.78 |
| 88123 | 250.0 | 205.9 | 14.4 | 13.1 | 206.62 |
| 11270 | 187.0 | 162.0 | 10.6 | 9.4  | 79.95  |
| #1    | 295.0 | .     | .    | 14.0 | .      |
| #2    | 270.0 | .     | 16.6 | 16.2 | .      |

| VARIABLES |         | REGRESION EQUATIONS | CORRELATION COEFFICIENT | N  |
|-----------|---------|---------------------|-------------------------|----|
| Y         | X       |                     |                         |    |
| 1.        | TFL SFL | Y = 1.19 X + 4.32   | 0.996                   | 23 |
| 2.        | TFL AB  | Y = 15.83 X + 10.23 | 0.977                   | 22 |
| 3.        | TFL CD  | Y = 15.57 X + 34.36 | 0.952                   | 25 |

**Evaluation:** The length dimension (AB) value is a reliable parameter to estimate the live fish length. The cornual width (CD) has a lower “r” because of the lack of symmetry of the cornua. See Fig. 5D

**Table 4: Lateral ethmoid - dimensions and measurements**

| NSM#  | TFL   | SFL   | AB   | CD   | TFW    |
|-------|-------|-------|------|------|--------|
| 87471 | 151.0 | 123.5 | 6.5  | 8.4  | 42.78  |
| 87472 | 143.9 | 116.1 | 6.1  | 7.5  | 34.52  |
| 87473 | 156.0 | 128.2 | 6.8  | 7.7  | 42.50  |
| 87474 | 145.5 | 119.0 | 6.2  | 7.3  | 38.50  |
| 87475 | 135.5 | 109.5 | 6.0  | 7.0  | 29.46  |
| 87477 | 142.0 | 115.2 | 6.1  | 7.1  | 30.94  |
| 87479 | 152.0 | 122.7 | 7.4  | 8.3  | 40.01  |
| 87480 | 155.9 | 128.8 | 7.4  | 7.3  | 44.40  |
| 87481 | 153.5 | 125.4 | 7.0  | 7.0  | 38.30  |
| 87482 | 149.8 | 122.9 | 7.0  | 7.7  | 43.71  |
| 87919 | 161.5 | 130.0 | 7.1  | 9.0  | 38.06  |
| 87920 | 132.7 | 106.4 | 6.0  | 7.0  | 21.01  |
| 87921 | 128.2 | 104.5 | 5.8  | 6.1  | 19.99  |
| 87922 | 177.8 | 146.3 | 7.8  | 9.3  | 61.01  |
| 87923 | 162.6 | 132.6 | 6.4  | 8.7  | 43.53  |
| 87924 | 168.0 | 140.3 | 7.1  | 9.3  | 53.41  |
| 87925 | 167.1 | 136.5 | ·    | ·    | 47.62  |
| 87926 | 174.4 | 147.4 | 8.0  | 9.3  | 54.28  |
| 87824 | 192.2 | 152.9 | 8.5  | 10.3 | 73.40  |
| 87825 | 181.4 | 148.2 | 7.6  | 8.6  | 66.05  |
| 88122 | 274.3 | 224.4 | 12.6 | 15.6 | 251.78 |
| 88123 | 250.0 | 205.9 | 11.2 | 13.3 | 206.62 |
| 11270 | 187.0 | 162.0 | 7.7  | 10.0 | 79.95  |
| #1    | 295.0 | ·     | 15.5 | 17.2 | ·      |
| #2    | 270.0 | ·     | 14.0 | 17.5 | ·      |

| VARIABLES |     | REGRESION<br>EQUATIONS | CORRELATION<br>COEFFICIENT<br>r | N  |
|-----------|-----|------------------------|---------------------------------|----|
| Y         | X   |                        |                                 |    |
| 1. TFL    | SFL | Y = 1.19 X + 4.32      | 0.996                           | 23 |
| 2. TFL    | AB  | Y = 17.58 X + 36.16    | 0.978                           | 24 |
| 3. TFL    | CD  | Y = 14.41 X + 40.64    | 0.980                           | 24 |

**Evaluation:** Both dimensions are reliable to estimate live fish size. See Fig. 6D.

**Table 5. Orbitosphenoid - dimensions and measurements**

| NSM#  | TFL   | SFL   | AB   | CD   | TFW    |
|-------|-------|-------|------|------|--------|
| 87471 | 151.0 | 123.5 | 6.0  | 4.6  | 42.78  |
| 87472 | 143.9 | 116.1 | .    | .    | 34.52  |
| 87473 | 156.0 | 128.2 | 7.1  | 4.7  | 42.50  |
| 87474 | 145.5 | 119.0 | 6.6  | 4.6  | 38.50  |
| 87475 | 135.5 | 109.5 | 6.5  | 4.6  | 29.46  |
| 87477 | 142.0 | 115.2 | 6.4  | 4.7  | 30.94  |
| 87479 | 152.0 | 122.7 | 7.8  | 5.0  | 40.01  |
| 87480 | 155.9 | 128.8 | 7.8  | 4.9  | 44.40  |
| 87481 | 153.5 | 125.4 | 7.2  | 5.2  | 38.30  |
| 87482 | 149.8 | 122.9 | 7.1  | 4.4  | 43.71  |
| 87919 | 161.5 | 130.0 | 7.0  | 5.0  | 38.06  |
| 87920 | 132.7 | 106.4 | 6.1  | 4.4  | 21.01  |
| 87921 | 128.2 | 104.5 | 5.1  | 5.1  | 19.99  |
| 87922 | 177.8 | 146.3 | 8.2  | 5.3  | 61.01  |
| 87923 | 162.6 | 132.6 | 7.6  | 4.6  | 43.53  |
| 87924 | 168.0 | 140.3 | 8.4  | 5.5  | 53.41  |
| 87925 | 167.1 | 136.5 | .    | .    | 47.62  |
| 87926 | 174.4 | 147.4 | 8.5  | 6.6  | 54.28  |
| 87824 | 192.2 | 152.9 | 9.1  | 5.5  | 73.40  |
| 87825 | 181.4 | 148.2 | 7.0  | 6.0  | 66.05  |
| 88122 | 274.3 | 224.4 | 12.3 | 7.5  | 251.78 |
| 88123 | 250.0 | 205.9 | 11.2 | 6.9  | 206.62 |
| 11270 | 187.0 | 162.0 | 8.5  | 5.5  | 79.95  |
| #1    | 295.0 | .     | 15.3 | 10.7 | .      |
| #2    | 270.0 | .     | 15.5 | 9.2  | .      |

|    | VARIABLES |     | REGRESION EQUATIONS | CORRELATION COEFFICIENT | N  |
|----|-----------|-----|---------------------|-------------------------|----|
|    | Y         | X   |                     | r                       |    |
| 1. | TFL       | SFL | Y = 1.19 X + 4.32   | 0.996                   | 23 |
| 2  | TFL       | AB  | Y = 16.70 X + 38.46 | 0.958                   | 23 |
| 3  | TFL       | CD  | Y = 27.62 X + 21.34 | 0.921                   | 23 |

**Evaluation:** Both dimensions look sound to estimate live fish size, although the width (CD) is a little lower. See Figs. 7B and 7D

**Table 6. Pterospheoid - dimensions and measurements**

| NSM#  | TFL   | SFL   | AB   | TFW    |
|-------|-------|-------|------|--------|
| 87471 | 151.0 | 123.5 | 6.4  | 42.78  |
| 87472 | 143.9 | 116.1 | 5.6  | 34.52  |
| 87473 | 156.0 | 128.2 | 5.1  | 42.50  |
| 87474 | 145.5 | 119.0 | 6.1  | 38.50  |
| 87475 | 135.5 | 109.5 | 5.5  | 29.46  |
| 87477 | 142.0 | 115.2 | 5.3  | 30.94  |
| 87479 | 152.0 | 122.7 | .    | 40.01  |
| 87480 | 155.9 | 128.8 | 6.4  | 44.40  |
| 87481 | 153.5 | 125.4 | 6.1  | 38.30  |
| 87482 | 149.8 | 122.9 | 6    | 43.71  |
| 87919 | 161.5 | 130.0 | 6.5  | 38.06  |
| 87920 | 132.7 | 106.4 | .    | 21.01  |
| 87921 | 128.2 | 104.5 | 6.2  | 19.99  |
| 87922 | 177.8 | 146.3 | .    | 61.01  |
| 87923 | 162.6 | 132.6 | 6.6  | 43.53  |
| 87924 | 168.0 | 140.3 | 6.6  | 53.41  |
| 87925 | 167.1 | 136.5 | .    | 47.62  |
| 87926 | 174.4 | 147.4 | 7.0  | 54.28  |
| 87824 | 192.2 | 152.9 | 7.4  | 73.40  |
| 87825 | 181.4 | 148.2 | 6.5  | 66.05  |
| 88122 | 274.3 | 224.4 | 11.7 | 251.78 |
| 88123 | 250.0 | 205.9 | 9.1  | 206.62 |
| 11270 | 187.0 | 162.0 | .    | 79.95  |
| #1    | 295.0 | .     | 12.1 | .      |
| #2    | 270.0 | .     | 11.6 | .      |

| VARIABLES |         | REGRESION<br>EQUATIONS | CORRELATION<br>COEFFICIENT<br>r | N  |
|-----------|---------|------------------------|---------------------------------|----|
| Y         | X       |                        |                                 |    |
| 1.        | TFL SFL | Y = 1.19 X + 4.32      | 0.996                           | 23 |
| 2         | TFL AB  | Y = 22.61 X + 16.98    | 0.968                           | 20 |

**Evaluation:** The pterospheoid is a strong bone. Although it has a small size, its length is a useful measurement. See Fig. 8D



**Table 7. Sphenotic - dimensions and measurements**

| NSM#  | TFL   | SFL   | AB   | CD  | TFW    |
|-------|-------|-------|------|-----|--------|
| 87471 | 151.0 | 123.5 | 10.1 | 3.3 | 42.78  |
| 87472 | 143.9 | 116.1 | 11.0 | 3.1 | 34.52  |
| 87473 | 156.0 | 128.2 | 11.7 | 3.4 | 42.50  |
| 87474 | 145.5 | 119.0 | 11.4 | 4.0 | 38.50  |
| 87475 | 135.5 | 109.5 | .    | .   | 29.46  |
| 87477 | 142.0 | 115.2 | 10.6 | 3.1 | 30.94  |
| 87479 | 152.0 | 122.7 | 11.1 | 3.2 | 40.01  |
| 87480 | 155.9 | 128.8 | 11.0 | 3.4 | 44.40  |
| 87481 | 153.5 | 125.4 | 6.3  | 3.2 | 38.30  |
| 87482 | 149.8 | 122.9 | 11.7 | .   | 43.71  |
| 87919 | 161.5 | 130.0 | 5.6  | 3.5 | 38.06  |
| 87920 | 132.7 | 106.4 | 8.2  | 2.8 | 21.01  |
| 87921 | 128.2 | 104.5 | 8.0  | 3.6 | 19.99  |
| 87922 | 177.8 | 146.3 | 12.6 | 3.9 | 61.01  |
| 87923 | 162.6 | 132.6 | 11.5 | 3.4 | 43.53  |
| 87924 | 168.0 | 140.3 | 12.2 | 3.7 | 53.41  |
| 87925 | 167.1 | 136.5 | 13.5 | 4.5 | 47.62  |
| 87926 | 174.4 | 147.4 | 12.5 | 3.7 | 54.28  |
| 87824 | 192.2 | 152.9 | 13.7 | 4.0 | 73.40  |
| 87825 | 181.4 | 148.2 | 10.8 | 3.5 | 66.05  |
| 88122 | 274.3 | 224.4 | .    | 5.1 | 251.78 |
| 88123 | 250.0 | 205.9 | 19.3 | 5.4 | 206.62 |
| 11270 | 187.0 | 162.0 | 7.8  | 4.1 | 79.95  |
| #1    | 295.0 | .     | 20.2 | 7.0 | .      |
| #2    | 270.0 | .     | 20.6 | 8.8 | .      |

| VARIABLES |         | REGRESION<br>EQUATIONS | CORRELATION<br>COEFFICIENT | N  |
|-----------|---------|------------------------|----------------------------|----|
| Y         | X       |                        |                            |    |
| 1.        | TFL SFL | Y = 1.19 X + 4.32      | 0.996                      | 23 |
| 2         | TFL AB  | Y = 9.75X + 9.71       | 0.855                      | 24 |
| 3         | TFL CD  | Y = 29.35X + 59.65     | 0.864                      | 23 |

**Evaluation:** The poor correlation is, possibly, due to the bone ending into a sharp point that breaks easily. See Fig. 9B.

**Table 8. Supraoccipital - dimensions and measurements**

| NSM#  | TFL   | SFL   | AB   | CD   | EF   | TFW    |
|-------|-------|-------|------|------|------|--------|
| 87471 | 151.0 | 123.5 | 14.5 | 9.6  | 7.4  | 42.78  |
| 87472 | 143.9 | 116.1 | 14.4 | 7.4  | 8.4  | 34.52  |
| 87473 | 156.0 | 128.2 | 14.6 | 8.0  | 10.5 | 42.50  |
| 87474 | 145.5 | 119.0 | 15.0 | 8.1  | 8.5  | 38.50  |
| 87475 | 135.5 | 109.5 | 12.5 | 6.8  | 8.4  | 29.46  |
| 87477 | 142.0 | 115.2 | 12.6 | 6.2  | 8.0  | 30.94  |
| 87479 | 152.0 | 122.7 | 14.6 | 8.7  | 8.2  | 40.01  |
| 87480 | 155.9 | 128.8 | 15.2 | 9.4  | 8.2  | 44.40  |
| 87481 | 153.5 | 125.4 | 14.3 | 7.3  | 8.4  | 38.30  |
| 87482 | 149.8 | 122.9 | 14.1 | 7.6  | 8.2  | 43.71  |
| 87919 | 161.5 | 130.0 | 16.1 | 8.1  | 7.3  | 38.06  |
| 87920 | 132.7 | 106.4 | 12.8 | 7.1  | 7.3  | 21.01  |
| 87921 | 128.2 | 104.5 | 12.0 | 7.1  | 7.8  | 19.99  |
| 87922 | 177.8 | 146.3 | 17.1 | 10.2 | 7.1  | 61.01  |
| 87923 | 162.6 | 132.6 | 15.6 | 8.4  | 8.3  | 43.53  |
| 87924 | 168.0 | 140.3 | 16.6 | 10.2 | 8.6  | 53.41  |
| 87925 | 167.1 | 136.5 | .    | .    | 8.6  | 47.62  |
| 87926 | 174.4 | 147.4 | 16.4 | 10.2 | 8.7  | 54.28  |
| 87824 | 192.2 | 152.9 | 18.7 | 10.5 | 9.6  | 73.40  |
| 87825 | 181.4 | 148.2 | 16.3 | 8.8  | 8.7  | 66.05  |
| 88122 | 274.3 | 224.4 | 27.0 | .    | 12.0 | 251.78 |
| 88123 | 250.0 | 205.9 | 20.4 | 9.3  | 11.3 | 206.62 |
| 11270 | 187.0 | 162.0 | 15.1 | 8.5  | 9.2  | 79.95  |
| #1    | 295.0 | .     | 26.4 | 15.1 | 14.6 | .      |
| #2    | 270.0 | .     | 25.5 | .    | 13.9 | .      |

| VARIABLES |         | REGRESION EQUATIONS   | CORRELATION COEFFICIENT | N  |
|-----------|---------|-----------------------|-------------------------|----|
| Y         | X       |                       |                         |    |
| 1.        | TFL SFL | $Y = 1.19 X + 4.32$   | 0.996                   | 23 |
| 2.        | TFL AB  | $Y = 10.88 X - 3.62$  | 0.972                   | 24 |
| 3.        | TFL CD  | $Y = 16.95 X + 19.63$ | 0.824                   | 22 |
| 4.        | TFL EF  | $Y = 21.41 X - 18.31$ | 0.901                   | 27 |

**Evaluation:** The length of the bone is the best measurement. The length of the spine, probably, is useless. The lower value of its width (EF) is due to the lack of perfect bilateral symmetry. See Fig. 11D.

**Table 9. Basioccipital - dimensions and measurements**

| NSM#  | TL    | SL    | AB   | CD  | TW     |
|-------|-------|-------|------|-----|--------|
| 87471 | 151.0 | 123.5 | 9.5  | 3.7 | 42.78  |
| 87472 | 143.9 | 116.1 | 9.3  | 3.3 | 34.52  |
| 87473 | 156.0 | 128.2 | 8.7  | 3.6 | 42.50  |
| 87474 | 145.5 | 119.0 | 9.5  | .   | 38.50  |
| 87475 | 135.5 | 109.5 | 8.0  | 3.3 | 29.46  |
| 87477 | 142.0 | 115.2 | 9.0  | 3.6 | 30.94  |
| 87479 | 152.0 | 122.7 | 9.5  | 3.8 | 40.01  |
| 87480 | 155.9 | 128.8 | 9.6  | 3.6 | 44.40  |
| 87481 | 153.5 | 125.4 | 9.6  | 3.9 | 38.30  |
| 87482 | 149.8 | 122.9 | .    | .   | 43.71  |
| 87919 | 161.5 | 130.0 | 10.2 | 3.8 | 38.06  |
| 87920 | 132.7 | 106.4 | 8.0  | 3.1 | 21.01  |
| 87921 | 128.2 | 104.5 | 8.4  | 3.0 | 19.99  |
| 87922 | 177.8 | 146.3 | .    | .   | 61.01  |
| 87923 | 162.6 | 132.6 | 9.3  | 4.6 | 43.53  |
| 87924 | 168.0 | 140.3 | 11.0 | 3.6 | 53.41  |
| 87925 | 167.1 | 136.5 | .    | .   | 47.62  |
| 87926 | 174.4 | 147.4 | 12.0 | 4.2 | 54.28  |
| 87824 | 192.2 | 152.9 | 13.0 | 4.8 | 73.40  |
| 87825 | 181.4 | 148.2 | 10.6 | 4.0 | 66.05  |
| 88122 | 274.3 | 224.4 | 16.0 | 7.0 | 251.78 |
| 88123 | 250.0 | 205.9 | 14.9 | 6.6 | 206.62 |
| 11270 | 187.0 | 162.0 | 9.3  | 4.6 | 79.95  |
| #1    | 295.0 | .     | 19.0 | 8.2 | .      |
| #2    | 270.0 | .     | 17.5 | 6.9 | .      |

| VARIABLES |         | REGRESION<br>EQUATIONS | CORRELATION<br>COEFFICIENTS | N  |
|-----------|---------|------------------------|-----------------------------|----|
| Y         | X       |                        |                             |    |
| 1.        | TFL SFL | Y = 1.19 X + 4.32      | 0.996                       | 23 |
| 2.        | TFL AB  | Y = 15.13 X + 11.52    | 0.967                       | 22 |
| 3.        | TFL CD  | Y = 33.64 X + 31.31    | 0.983                       | 21 |

Evaluation. The lower value of “r” based on the bone’s length measurement (AB) is due to the difficulty in measuring the fragile spicules of its anterior end. See Fig. 12B.

**Table 10. Frontal - dimensions and measurements.**

| NSM#  | TFL   | SFL   | AB   | CD   | TFW    |
|-------|-------|-------|------|------|--------|
| 87471 | 151.0 | 123.5 | 17.6 | 5.4  | 42.78  |
| 87472 | 143.9 | 116.1 | 15.7 | 5.0  | 34.52  |
| 87473 | 156.0 | 128.2 | 18.2 | 5.6  | 42.50  |
| 87474 | 145.5 | 119.0 | 17.3 | 5.3  | 38.50  |
| 87475 | 135.5 | 109.5 | 15.1 | 5.0  | 29.46  |
| 87477 | 142.0 | 115.2 | 12.5 | 5.4  | 30.94  |
| 87479 | 152.0 | 122.7 | 20.6 | 5.9  | 40.01  |
| 87480 | 155.9 | 128.8 | 17.1 | 5.2  | 44.40  |
| 87481 | 153.5 | 125.4 | 16.2 | 5.4  | 38.30  |
| 87482 | 149.8 | 122.9 | 18.3 | 5.6  | 43.71  |
| 87919 | 161.5 | 130.0 | 18.4 | 5.4  | 38.06  |
| 87920 | 132.7 | 106.4 | 14.2 | 5.1  | 21.01  |
| 87921 | 128.2 | 104.5 | 13.3 | 4.2  | 19.99  |
| 87922 | 177.8 | 146.3 | 21.4 | 6.0  | 61.01  |
| 87923 | 162.6 | 132.6 | 19.8 | 5.0  | 43.53  |
| 87924 | 168.0 | 140.3 | 19.7 | 5.5  | 53.41  |
| 87925 | 167.1 | 136.5 | .    | .    | 47.62  |
| 87926 | 174.4 | 147.4 | 20.5 | 6.0  | 54.28  |
| 87824 | 192.2 | 152.9 | 22.8 | 6.3  | 73.40  |
| 87825 | 181.4 | 148.2 | 18.9 | 6.0  | 66.05  |
| 88122 | 274.3 | 224.4 | 31.5 | 8.1  | 251.78 |
| 88123 | 250.0 | 205.9 | 28.0 | 7.8  | 206.62 |
| 11270 | 187.0 | 162.0 | 19.0 | 6.5  | 79.95  |
| #1    | 295.0 | .     | 34.4 | 11.0 | .      |
| #2    | 270.0 | .     | 35.8 | 9.0  | .      |

| VARIABLES |     | REGRESION<br>EQUATIONS | CORRELATION<br>COEFFICIENTS |       |    |
|-----------|-----|------------------------|-----------------------------|-------|----|
| Y         | X   |                        | r                           | N     |    |
| 1.        | TFL | SFL                    | Y = 1.19 X + 4.32           | 0.996 | 23 |
| 2.        | TFL | AB                     | Y = 7.32 X + 28.27          | 0.964 | 24 |
| 3.        | TFL | CD                     | Y = 29.90 X - 4.83          | 0.954 | 24 |

Evaluation. The lack of perfect lateral symmetry results in a lower “r” value using the bone’s width (CD). See Fig. 14D.

**Table 11. Parasphenoid - dimensions and measurements.**

| NSM#  | TFL   | SFL   | AB   | CD   | TFW    |
|-------|-------|-------|------|------|--------|
| 87471 | 151.0 | 123.5 | 23.7 | 5.0  | 42.78  |
| 87472 | 143.9 | 116.1 | 21.5 | 5.1  | 34.52  |
| 87473 | 156.0 | 128.2 | 25.0 | 5.7  | 42.50  |
| 87474 | 145.5 | 119.0 | 24.5 | 4.5  | 38.50  |
| 87475 | 135.5 | 109.5 | .    | .    | 29.46  |
| 87477 | 142.0 | 115.2 | 23.7 | 5.0  | 30.94  |
| 87479 | 152.0 | 122.7 | 24.3 | 5.4  | 40.01  |
| 87480 | 155.9 | 128.8 | 26.1 | 5.3  | 44.40  |
| 87481 | 153.5 | 125.4 | 24.8 | 5.4  | 38.30  |
| 87482 | 149.8 | 122.9 | .    | 5.2  | 43.71  |
| 87919 | 161.5 | 130.0 | 25.1 | 5.5  | 38.06  |
| 87920 | 132.7 | 106.4 | 21.4 | 4.6  | 21.01  |
| 87921 | 128.2 | 104.5 | 19.7 | 4.6  | 19.99  |
| 87922 | 177.8 | 146.3 | .    | 5.6  | 61.01  |
| 87923 | 162.6 | 132.6 | 24.8 | 5.3  | 43.53  |
| 87924 | 168.0 | 140.3 | 29.7 | 6.0  | 53.41  |
| 87925 | 167.1 | 136.5 | .    | .    | 47.62  |
| 87926 | 174.4 | 147.4 | 27.3 | 6.0  | 54.28  |
| 87824 | 192.2 | 152.9 | 32.5 | 6.0  | 73.40  |
| 87825 | 181.4 | 148.2 | 27.1 | 5.9  | 66.05  |
| 88122 | 274.3 | 224.4 | 44.6 | 9.3  | 251.78 |
| 88123 | 250.0 | 205.9 | 38.7 | 7.3  | 206.62 |
| 11270 | 187.0 | 162.0 | 21.0 | .    | 79.95  |
| #1    | 295.0 | .     | 48.2 | 12.1 | .      |
| #2    | 270.0 | .     | 48.1 | 10.1 | .      |

| VARIABLES |     | REGRESION<br>EQUATIONS | CORRELATION<br>COEFFICIENTS |          |
|-----------|-----|------------------------|-----------------------------|----------|
| Y         | X   |                        | r                           | N        |
| 1.        | TFL | SFL                    | Y = 1.19 X + 4.32           | 0.996 23 |
| 2.        | TFL | AB                     | Y = 5.49 X + 25.12          | 0.958 21 |
| 3.        | TFL | CD                     | Y = 23.98 X + 31.05         | 0.954 22 |

Evaluation. In spite of the spicules of the anterior and posterior ends of the bone, the correlation is acceptable. See Fig. 15A.

**Table 12. Vomer - dimension and measurements.**

| NSM#  | TFL   | SFL   | AB   | TFW    |
|-------|-------|-------|------|--------|
| 87471 | 151.0 | 123.5 | 6.2  | 42.78  |
| 87472 | 143.9 | 116.1 | 5.0  | 34.52  |
| 87473 | 156.0 | 128.2 | 4.9  | 42.50  |
| 87474 | 145.5 | 119.0 | .    | 38.50  |
| 87475 | 135.5 | 109.5 | 5.0  | 29.46  |
| 87477 | 142.0 | 115.2 | 5.3  | 30.94  |
| 87479 | 152.0 | 122.7 | 6.4  | 40.01  |
| 87480 | 155.9 | 128.8 | 6.1  | 44.40  |
| 87481 | 153.5 | 125.4 | 5.7  | 38.30  |
| 87482 | 149.8 | 122.9 | 5.6  | 43.71  |
| 87919 | 161.5 | 130.0 | 11.0 | 38.06  |
| 87920 | 132.7 | 106.4 | 4.1  | 21.01  |
| 87921 | 128.2 | 104.5 | 3.2  | 19.99  |
| 87922 | 177.8 | 146.3 | 7.2  | 61.01  |
| 87923 | 162.6 | 132.6 | 6.2  | 43.53  |
| 87924 | 168.0 | 140.3 | 7.0  | 53.41  |
| 87925 | 167.1 | 136.5 | .    | 47.62  |
| 87926 | 174.4 | 147.4 | 6.8  | 54.28  |
| 87824 | 192.2 | 152.9 | 8.3  | 73.40  |
| 87825 | 181.4 | 148.2 | 6.4  | 66.05  |
| 88122 | 274.3 | 224.4 | 11.4 | 251.78 |
| 88123 | 250.0 | 205.9 | 9.6  | 206.62 |
| 11270 | 187.0 | 162.0 | 7.7  | 79.95  |
| #1    | 295.0 | .     | 13.0 | .      |
| #2    | 270.0 | .     | 14.2 | .      |

| VARIABLES |     | REGRESION<br>EQUATIONS | CORRELATION<br>COEFFICIENTS |       |    |
|-----------|-----|------------------------|-----------------------------|-------|----|
| Y         | X   |                        | r                           | N     |    |
| 1.        | TFL | SFL                    | $Y = 1.19 X + 4.32$         | 0.996 | 23 |
| 2.        | TFL | AB                     | $Y = 15.12 X + 68.73$       | 0.895 | 21 |

Evaluation. The poor value of this measurement can be attributed to the fragility of the bone and lack of bilateral symmetry. See Fig. 15C.

**Table 13. Hyomandibular - dimensions and measurements.**

| NSM#  | TFL   | SFL   | AB   | AC   | CD   | TFW    |
|-------|-------|-------|------|------|------|--------|
| 87471 | 151.0 | 123.5 | 11.5 | 10.6 | 10.1 | 42.78  |
| 87472 | 143.9 | 116.1 | 11.2 | 10.0 | 9.6  | 34.52  |
| 87473 | 156.0 | 128.2 | 12.1 | 11.0 | 10.2 | 42.50  |
| 87474 | 145.5 | 119.0 | 11.5 | 10.2 | 9.6  | 38.50  |
| 87475 | 135.5 | 109.5 | 10.3 | 9.4  | 9.1  | 29.46  |
| 87477 | 142.0 | 115.2 | 10.8 | 9.6  | 9.2  | 30.94  |
| 87479 | 152.0 | 122.7 | 11.4 | 10.4 | 9.6  | 40.01  |
| 87480 | 155.9 | 128.8 | 11.9 | 11.1 | 10.3 | 44.40  |
| 87481 | 153.5 | 125.4 | 11.8 | 10.5 | 9.7  | 38.30  |
| 87482 | 149.8 | 122.9 | 11.6 | 10.3 | 10.1 | 43.71  |
| 87919 | 161.5 | 130.0 | 12.4 | 11.0 | 10.6 | 38.06  |
| 87920 | 132.7 | 106.4 | 10.2 | 8.0  | 8.3  | 21.01  |
| 87921 | 128.2 | 104.5 | 9.0  | 8.1  | 7.0  | 19.99  |
| 87922 | 177.8 | 146.3 | 13.8 | 12.2 | 11.5 | 61.01  |
| 87923 | 162.6 | 132.6 | 12.0 | 10.9 | 10.0 | 43.53  |
| 87924 | 168.0 | 140.3 | 14.6 | 11.4 | 10.8 | 53.41  |
| 87925 | 167.1 | 136.5 | 12.7 | 11.1 | 11.0 | 47.62  |
| 87926 | 174.4 | 147.4 | 13.1 | 12.0 | 11.4 | 54.28  |
| 87824 | 192.2 | 152.9 | 14.6 | 13.3 | 13.1 | 73.40  |
| 87825 | 181.4 | 148.2 | 15.3 | 14.4 | 14.6 | 66.05  |
| 88122 | 274.3 | 224.4 | 21.0 | 20.2 | 19.1 | 251.78 |
| 88123 | 250.0 | 205.9 | 18.7 | 17.3 | 16.8 | 206.62 |
| 11270 | 187.0 | 162.0 | 13.9 | 12.6 | 12.2 | 79.95  |
| #1    | 295.0 | .     | 25.5 | 21.2 | 22.1 | .      |
| #2    | 270.0 | .     | 24.3 | 20.0 | 20.8 | .      |

|    | VARIABLES |     | REGRESION EQUATIONS   | CORRELATION COEFFICIENTS | N  |
|----|-----------|-----|-----------------------|--------------------------|----|
|    | Y         | X   |                       | r                        |    |
| 1. | TFL       | SFL | $Y = 1.19 X + 4.32$   | 0.996                    | 23 |
| 2. | TFL       | AB  | $Y = 10.70 X + 28.49$ | 0.980                    | 25 |
| 3. | TFL       | AC  | $Y = 12.61 X + 21.57$ | 0.990                    | 25 |
| 4. | TFL       | CD  | $Y = 11.71 X + 37.21$ | 0.982                    | 25 |

Evaluation. The hyomandibular is a strong bone with well-defined landmarks. All three correlation coefficients are very good. See Fig. 17D.

**Table 14. Quadrate - dimensions and measurements.**

| NSM#  | TFL    | SFL   | AB   | CD    | TFW     |
|-------|--------|-------|------|-------|---------|
| 87471 | 1510.0 | 123.5 | 5.5  | 4.1   | 42.78   |
| 87472 | 143.9  | 116.1 | 5.2  | 4.7   | 34.52   |
| 87473 | 156.0  | 128.2 | 6.4  | 5.1   | 42.50   |
| 87474 | 145.5  | 119.0 | 6.1  | 4.4   | 38.50   |
| 87475 | 135.5  | 109.5 | 5.2  | 4.2   | 29.46   |
| 87477 | 142.0  | 115.2 | 5.6  | 4.9   | 30.94 R |
| 87479 | 152.0  | 122.7 | 5.8  | 4.6   | 40.01   |
| 87480 | 155.9  | 128.8 | 6.0  | 6.1   | 44.40 R |
| 87481 | 153.5  | 125.4 | 6.4  | 4.6   | 38.30   |
| 87482 | 149.8  | 122.9 | 6.0  | 4.9   | 43.71 R |
| 87919 | 161.5  | 130.0 | 6.8  | 4.5   | 38.06   |
| 87920 | 132.7  | 106.4 | 4.1  | 4.0   | 21.01   |
| 87921 | 128.2  | 104.5 | 4.6  | 4.2   | 19.99   |
| 87922 | 177.8  | 146.3 | 7.0  | 5.4   | 61.01   |
| 87923 | 162.6  | 132.6 | 6.4  | 5.1   | 43.53   |
| 87924 | 168.0  | 140.3 | 7.1  | 6.4   | 53.41   |
| 87925 | 167.1  | 136.5 | 5.8  | 5.1   | 47.62   |
| 87926 | 174.4  | 147.4 | 7.0  | 5.6   | 54.28   |
| 87824 | 192.2  | 152.9 | 7.3  | 6.4   | 73.40   |
| 87825 | 181.4  | 148.2 | 7.5  | 6.2   | 66.05   |
| 88122 | 274.3  | 224.4 | 12.0 | 110.0 | 251.78  |
| 88123 | 250.0  | 205.9 | 9.7  | 8.3   | 206.62  |
| 11270 | 187.0  | 162.0 | .    | .     | 79.95   |
| #1    | 295.0  | .     | 13.1 | 10.0  | .       |
| #2    | 270.0  | .     | 13.0 | 11.8  | .       |

|    | VARIABLES |     | REGRESION EQUATIONS | CORRELATION  | N  |
|----|-----------|-----|---------------------|--------------|----|
|    | Y         | X   |                     | COEFFICIENTS |    |
|    |           |     |                     | r            |    |
| 1. | TFL       | SFL | Y = 1.19 X + 4.32   | 0.996        | 23 |
| 2. | TFL       | AB  | Y = 18.98 X + 40.37 | 0.979        | 25 |
| 3. | TFL       | CD  | Y = 20.55 X + 54.61 | 0.953        | 25 |

Evaluation. The best value is obtained using the height (AB) of the bone. The width (CD) measurements include an area of laminar bone ending in fragile spicules, resulting in the lower value of "r." See Fig. 18B.



**Table 15. Preopercle - dimension measurements.**

| NSM#  | TFL   | SFL   | AB   | FTW    |
|-------|-------|-------|------|--------|
| 87471 | 151.0 | 123.5 | 10.1 | 42.78  |
| 87472 | 143.9 | 116.1 | 10.3 | 34.52  |
| 87473 | 156.0 | 128.2 | 12.2 | 42.50  |
| 87474 | 145.5 | 119.0 | 10.9 | 38.50  |
| 87475 | 135.5 | 109.5 | 10.0 | 29.46  |
| 87477 | 142.0 | 115.2 | 10.9 | 30.94  |
| 87479 | 152.0 | 122.7 | 11.6 | 40.01  |
| 87480 | 155.9 | 128.8 | 11.4 | 44.40  |
| 87481 | 153.5 | 125.4 | 11.5 | 38.30  |
| 87482 | 149.8 | 122.9 | 11.5 | 43.71  |
| 87919 | 161.5 | 130.0 | 12.6 | 38.06  |
| 87920 | 132.7 | 106.4 | 10.1 | 21.01  |
| 87921 | 128.2 | 104.5 | 8.6  | 19.99  |
| 87922 | 177.8 | 146.3 | 13.6 | 61.01  |
| 87923 | 162.6 | 132.6 | 11.3 | 43.53  |
| 87924 | 168.0 | 140.3 | 13.2 | 53.41  |
| 87925 | 167.1 | 136.5 | 13.1 | 47.62  |
| 87926 | 174.4 | 147.4 | 13.2 | 54.28  |
| 87824 | 192.2 | 152.9 | 15.3 | 73.40  |
| 87825 | 181.4 | 148.2 | 14.4 | 66.05  |
| 88122 | 274.3 | 224.4 | 22.2 | 251.78 |
| 88123 | 250.0 | 205.9 | .    | 206.62 |
| 11270 | 187.0 | 162.0 | .    | 79.95  |
| #1    | 295.0 | .     | 25.0 | .      |
| #2    | 270.0 | .     | 24.6 | .      |

| VARIABLES |         | REGRESION<br>EQUATIONS | CORRELATION<br>COEFFICIENT S | N  |
|-----------|---------|------------------------|------------------------------|----|
| Y         | X       |                        |                              |    |
| 1.        | TFL SFL | $Y = 1.19 X + 4.32$    | 0.996                        | 23 |
| 2.        | TFL AB  | $Y = 10.03 X + 38.48$  | 0.990                        | 23 |

Evaluation. Well ossified bone and easy to measure. See Fig. 18D

**Table 16. Dentary - dimensions and measurements.**

| NSM#  | TFL   | SFL   | AB   | AC   | CD   | TFW    |
|-------|-------|-------|------|------|------|--------|
| 87471 | 151.0 | 123.5 | 14.2 | 15.5 | 4.8  | 42.78  |
| 87472 | 143.9 | 116.1 | 12.1 | 13.6 | 4.5  | 34.52  |
| 87473 | 156.0 | 128.2 | 14.5 | 11.3 | 5.2  | 42.50  |
| 87474 | 145.5 | 119.0 | 13.0 | 15.5 | 4.6  | 38.50  |
| 87475 | 135.5 | 109.5 | 11.8 | 13.4 | 4.4  | 29.46  |
| 87477 | 142.0 | 115.2 | 12.5 | 15.5 | 4.4  | 30.94  |
| 87479 | 152.0 | 122.7 | 13.6 | 15.9 | 4.5  | 40.01  |
| 87480 | 155.9 | 128.8 | 14.7 | 17.7 | 5.4  | 44.40  |
| 87481 | 153.5 | 125.4 | 11.5 | 14.1 | 4.3  | 38.30  |
| 87482 | 149.8 | 122.9 | 14.1 | 16.4 | 5.1  | 43.71  |
| 87919 | 161.5 | 130.0 | 15.2 | 16.4 | 5.5  | 38.06  |
| 87920 | 132.7 | 106.4 | 10.3 | 12.6 | 3.8  | 21.01  |
| 87921 | 128.2 | 104.5 | 9.0  | 9.6  | 3.5  | 19.99  |
| 87922 | 177.8 | 146.3 | 16.8 | 19.3 | 5.3  | 61.01  |
| 87923 | 162.6 | 132.6 | 14.5 | .    | 5.0  | 43.53  |
| 87924 | 168.0 | 140.3 | 15.6 | 17.8 | 5.4  | 53.41  |
| 87925 | 167.1 | 136.5 | 15.0 | 18.1 | 5.3  | 47.62  |
| 87926 | 174.4 | 147.4 | 15.4 | 18.6 | 6.4  | 54.28  |
| 87824 | 192.2 | 152.9 | 19.1 | 21.6 | 7.2  | 73.40  |
| 87825 | 181.4 | 148.2 | 21.4 | 24.6 | 8.5  | 66.05  |
| 88122 | 274.3 | 224.4 | 28.6 | 30.4 | 10.4 | 251.78 |
| 88123 | 250.0 | 205.9 | 24.0 | 27.0 | 8.2  | 206.62 |
| 11270 | 187.0 | 162.0 | .    | .    | .    | 79.95  |
| #1    | 295.0 | .     | 36.6 | 39.1 | 11.4 | .      |
| #2    | 270.0 | .     | 31.6 | 33.1 | 10.7 | .      |

|    | VARIABLES |     | REGRESION<br>EQUATIONS | CORRELATION<br>COEFFICIENTS |    |
|----|-----------|-----|------------------------|-----------------------------|----|
|    | Y         | X   |                        | r                           | N  |
| 1. | TFL       | SFL | Y = 1.19 X + 4.32      | 0.996                       | 23 |
| 2. | TFL       | AB  | Y = 6.68 X + 63.01     | 0.976                       | 24 |
| 3. | TFL       | AC  | Y = 6.34 X + 55.93     | 0.962                       | 23 |
| 4. | TFL       | CD  | Y = 20.25 X + 54.49    | 0.960                       | 24 |

Evaluation. All values are acceptable due to its complete ossification and clearly defined points of reference. A drawback is that the degree of the curvature of the bone influences the value of the upper margin length (AB). See Fig. 20D

**Table 17. Angular - dimensions and measurements.**

| NSM#  | TFL   | SFL   | AB   | AC   | CD   | TFW    |
|-------|-------|-------|------|------|------|--------|
| 87471 | 151.0 | 123.5 | 11.4 | 7.5  | 4.3  | 42.78  |
| 87472 | 143.9 | 116.1 | 11.1 | .    | 4.1  | 34.52  |
| 87473 | 156.0 | 128.2 | 12.7 | 8.1  | 4.6  | 42.50  |
| 87474 | 145.5 | 119.0 | 11.6 | 7.3  | 4.2  | 38.50  |
| 87475 | 135.5 | 109.5 | 9.7  | 5.0  | 4.5  | 29.46  |
| 87477 | 142.0 | 115.2 | 11.6 | 7.3  | 4.1  | 30.94  |
| 87479 | 152.0 | 122.7 | 11.7 | 7.4  | 4.2  | 40.01  |
| 87480 | 155.9 | 128.8 | 13.5 | 7.9  | 4.5  | 44.40  |
| 87481 | 153.5 | 125.4 | 10.1 | 5.7  | 3.5  | 38.30  |
| 87482 | 149.8 | 122.9 | 12.2 | 7.6  | 4.5  | 43.71  |
| 87919 | 161.5 | 130.0 | 12.6 | 7.5  | 4.6  | 38.06  |
| 87920 | 132.7 | 106.4 | 9.5  | .    | 3.4  | 21.01  |
| 87921 | 128.2 | 104.5 | 9.3  | .    | 3.1  | 19.99  |
| 87922 | 177.8 | 146.3 | 14.5 | 10.2 | 5.1  | 61.01  |
| 87923 | 162.6 | 132.6 | 12.4 | 8.2  | 4.2  | 43.53  |
| 87924 | 168.0 | 140.3 | 13.0 | 9.0  | 5.3  | 53.41  |
| 87925 | 167.1 | 136.5 | 13.2 | 8.5  | 4.4  | 47.62  |
| 87926 | 174.4 | 147.4 | 13.3 | 9.1  | 5.2  | 54.28  |
| 87824 | 192.2 | 152.9 | 16.4 | 11.0 | 6.1  | 73.40  |
| 87825 | 181.4 | 148.2 | 17.7 | 11.8 | 6.7  | 66.05  |
| 88122 | 274.3 | 224.4 | 22.3 | 16.4 | 9.1  | 251.78 |
| 88123 | 250.0 | 205.9 | 19.3 | 14.6 | 7.6  | 206.62 |
| 11270 | 187.0 | 162.0 | 13.4 | 8.8  | 5.2  | 79.95  |
| #1    | 295.0 | .     | 21.9 | 18.5 | 9.6  | .      |
| #2    | 270.0 | .     | 22.5 | 18.1 | 10.3 | .      |

| VARIABLES |         | REGRESION<br>EQUATIONS | CORRELATION<br>COEFFICIENT | N  |
|-----------|---------|------------------------|----------------------------|----|
| Y         | X       |                        |                            |    |
| 1.        | TFL SFL | $Y = 1.19 X + 4.32$    | 0.996                      | 23 |
| 2.        | TFL AB  | $Y = 11.29 X + 19.58$  | 0.961                      | 25 |
| 3.        | TFL AC  | $Y = 11.90 X + 65.40$  | 0.940                      | 22 |
| 4.        | TFL CD  | $Y = 23.12 X + 53.82$  | 0.963                      | 25 |

Evaluation. The angular is well-ossified bone. Its anterior margin length (AC) has a lower correlation value, because of the difficulty in applying the caliper to its round coronoid process. See Fig. 21D.

**Table 18. Hyoid arch - length measurements.**

| NSM#  | TFL   | SFL   | AB   | TFW     |
|-------|-------|-------|------|---------|
| 87471 | 151.0 | 123.5 | .    | 42.78   |
| 87472 | 143.9 | 116.1 | .    | 34.52   |
| 87473 | 156.0 | 128.2 | 18.7 | 42.50 R |
| 87474 | 145.5 | 119.0 | .    | 38.50   |
| 87475 | 135.5 | 109.5 | 16.3 | 29.46   |
| 87477 | 142.0 | 115.2 | 14.3 | 30.94   |
| 87479 | 152.0 | 122.7 | 18.2 | 40.01   |
| 87480 | 155.9 | 128.8 | 19.1 | 44.40   |
| 87481 | 153.5 | .     | 18.5 | 38.30   |
| 87482 | 149.8 | 122.9 | 18.9 | 43.71   |
| 87919 | 161.5 | 130.0 | .    | 38.06   |
| 87920 | 132.7 | 106.4 | .    | 21.01   |
| 87921 | 128.2 | 104.5 | .    | 19.99   |
| 87922 | 177.8 | 146.3 | .    | 61.01   |
| 87923 | 162.6 | 132.6 | .    | 43.53   |
| 87924 | 168.0 | 140.3 | 20.4 | 53.41   |
| 87925 | 167.1 | 136.5 | 20.3 | 47.62   |
| 87926 | 174.4 | 147.4 | 20.9 | 54.28   |
| 87824 | 192.2 | 152.9 | 23.2 | 73.40   |
| 87825 | 181.4 | 148.2 | 26.1 | 66.05   |
| 88122 | 274.3 | 224.4 | 34.3 | 251.78  |
| 88123 | 250.0 | 205.9 | 29.9 | 206.62  |
| 11270 | 187.0 | 162.0 | 20.9 | 79.95   |
| #1    | 295.0 | .     | 39.8 | .       |
| #2    | 270.0 | .     | 38.4 | .       |

| VARIABLES |         | REGRESION<br>EQUATIONS | CORRELATION<br>COEFFICIENT<br>r | N  |
|-----------|---------|------------------------|---------------------------------|----|
| Y         | X       |                        |                                 |    |
| 1.        | TFL SFL | Y = 1.19 X + 4.32      | 0.996                           | 23 |
| 2.        | TFL AB  | Y = 6.48 X + 36.77     | 0.975                           | 17 |

Evaluation. Well ossified bone with clearly defined points of reference. See Fig. 22B

**Table 19. Ceratohyal - dimensions and measurements.**

| NSM#  | TFL   | SFL   | CD   | DE   | TFW    |
|-------|-------|-------|------|------|--------|
| 87471 | 151.0 | 123.5 | 4.3  | 9.2  | 42.78  |
| 87472 | 143.9 | 116.1 | .    | .    | 34.52  |
| 87473 | 156.0 | 128.2 | 4.9  | 9.6  | 42.50  |
| 87474 | 145.5 | 119.0 | 4.5  | 9.6  | 38.50  |
| 87475 | 135.5 | 109.5 | 3.9  | 9.3  | 29.46  |
| 87477 | 142.0 | 115.2 | 4.1  | 10.0 | 30.94  |
| 87479 | 152.0 | 122.7 | 4.5  | 10.0 | 40.01  |
| 87480 | 155.9 | 128.8 | 4.8  | 10.3 | 44.40  |
| 87481 | 153.5 | 125.4 | 4.6  | 10.0 | 38.30  |
| 87482 | 149.8 | 122.9 | 4.6  | 10.1 | 43.71  |
| 87919 | 161.5 | 130.0 | 4.5  | 11.3 | 38.06  |
| 87920 | 132.7 | 106.4 | 3.2  | 8.0  | 21.01  |
| 87921 | 128.2 | 104.5 | .    | .    | 19.99  |
| 87922 | 177.8 | 146.3 | 5.7  | 16.5 | 61.01  |
| 87923 | 162.6 | 132.6 | 4.4  | 10.3 | 43.53  |
| 87924 | 168.0 | 140.3 | 5.5  | 11.3 | 53.41  |
| 87925 | 167.1 | 136.5 | 4.1  | 9.0  | 47.62  |
| 87926 | 174.4 | 147.4 | 5.4  | 11.3 | 54.28  |
| 87824 | 192.2 | 152.9 | 6.6  | 12.4 | 73.40  |
| 87825 | 181.4 | 148.2 | .    | .    | 66.05  |
| 88122 | 274.3 | 224.4 | 9.4  | 19.2 | 251.78 |
| 88123 | 250.0 | 205.9 | 7.5  | 16.1 | 206.62 |
| 11270 | 187.0 | 162.0 | 5.9  | 11.2 | 79.95  |
| #1    | 295   | .     | 11.3 | 22.4 | .      |
| #2    | 270   | .     | 10.9 | 21.6 | .      |

| VARIABLES |         | REGRESION<br>EQUATIONS | CORRELATION<br>COEFFICIENT | N  |
|-----------|---------|------------------------|----------------------------|----|
| Y         | X       |                        |                            |    |
| 1.        | TFL SFL | $Y = 1.19 X + 4.32$    | 0.996                      | 23 |
| 2.        | TFL CD  | $Y = 20.90 X + 61.37$  | 0.971                      | 22 |
| 3.        | TFL DE  | $Y = 10.80 X + 47.86$  | 0.944                      | 22 |

Evaluation. Well ossified bone. The lower value of its length (DE) is due to the difficulty in applying the calipers when this bone is attached to the hypohyal and to the epihyal. See Fig. 22B.

**Table 20. Urohyal - dimensions and measurements.**

| NSM#  | TFL   | SFL   | AB   | CD  | EF   | TFW    |
|-------|-------|-------|------|-----|------|--------|
| 87471 | 151.0 | 123.5 | 5.8  | 2.4 | 5.4  | 42.78  |
| 87472 | 143.9 | 116.1 | .    | .   | .    | 34.52  |
| 87473 | 156.0 | 128.2 | 5.4  | 2.9 | .    | 42.50  |
| 87474 | 145.5 | 119.0 | 5.6  | 2.4 | 5.4  | 38.50  |
| 87475 | 135.5 | 109.5 | .    | .   | .    | 29.46  |
| 87477 | 142.0 | 115.2 | .    | .   | .    | 30.94  |
| 87479 | 152.0 | 122.7 | 5.7  | 2.3 | 5.0  | 40.01  |
| 87480 | 155.9 | 128.8 | 5.3  | 2.3 | 5.1  | 44.40  |
| 87481 | 153.5 | 125.4 | 5.0  | 2.3 | 5.4  | 38.30  |
| 87482 | 149.8 | 122.9 | .    | .   | .    | 43.71  |
| 87919 | 161.5 | 130.0 | 6.0  | 2.6 | 5.7  | 38.06  |
| 87920 | 132.7 | 106.4 | .    | .   | .    | 21.01  |
| 87921 | 128.2 | 104.5 | .    | .   | .    | 19.99  |
| 87922 | 177.8 | 146.3 | 6.6  | 3.0 | 7.3  | 61.01  |
| 87923 | 162.6 | 132.6 | .    | .   | .    | 43.53  |
| 87924 | 168.0 | 140.3 | 6.3  | 2.5 | 6.0  | 53.41  |
| 87925 | 167.1 | 136.5 | .    | .   | .    | 47.62  |
| 87926 | 174.4 | 147.4 | .    | 2.9 | 6.0  | 54.28  |
| 87824 | 192.2 | 152.9 | 7.0  | 3.0 | .    | 73.40  |
| 87825 | 181.4 | 148.2 | .    | .   | .    | 66.05  |
| 88122 | 274.3 | 224.4 | 11.8 | 4.2 | 9.2  | 251.78 |
| 88123 | 250.0 | 205.9 | 10.1 | 3.6 | 8.0  | 206.62 |
| 11270 | 187.0 | 162.0 | .    | .   | 6.3  | 79.95  |
| #1    | 295.0 | .     | 12.1 | 4.1 | 10.8 | .      |
| #2    | 270.0 | .     | 15.1 | 4.3 | 10.0 | .      |

| VARIABLES |         | REGRESION<br>EQUATIONS | CORRELATION<br>COEFFICIENT<br>r | N  |
|-----------|---------|------------------------|---------------------------------|----|
| Y         | X       |                        |                                 |    |
| 1.        | TFL SFL | Y = 1.19 X + 4.32      | 0.996                           | 23 |
| 2.        | TFL AB  | Y = 15.99 X + 69.89    | 0.948                           | 16 |
| 3.        | TFL CD  | Y = 69.77 X - 16.56    | 0.963                           | 15 |
| 4.        | TFL EF  | Y = 26.84 X + 10.70    | 0.971                           | 14 |

Evaluation. The urohyal is very small and difficult to measure. See Fig. 22C.

**Table 21. Weberian apparatus - dimensions and measurements.**

| NSM#  | TFL   | SFL   | AB   | CD   | EF   | TFW    |
|-------|-------|-------|------|------|------|--------|
| 87471 | 151.0 | 123.5 | 9.9  | 17.4 | 9.0  | 42.78  |
| 87472 | 143.9 | 116.1 | 10.4 | 17.8 | 9.5  | 34.52  |
| 87473 | 156.0 | 128.2 | .    | 17.6 | .    | 42.50  |
| 87474 | 145.5 | 119.0 | 10.6 | 18.0 | 9.1  | 38.50  |
| 87475 | 135.5 | 109.5 | 9.7  | 15.5 | 8.2  | 29.46  |
| 87477 | 142.0 | 115.2 | 10.1 | 17.1 | 8.7  | 30.94  |
| 87479 | 152.0 | 122.7 | 10.7 | 17.0 | 9.2  | 40.01  |
| 87480 | 155.9 | 128.8 | 10.7 | 19.0 | 9.5  | 44.40  |
| 87481 | 153.5 | 125.4 | 11.1 | .    | 10.0 | 38.30  |
| 87482 | 149.8 | 122.9 | 10.5 | 18.4 | 10.0 | 43.71  |
| 87919 | 161.5 | 130.0 | 11.8 | 19.3 | 10.2 | 38.06  |
| 87920 | 132.7 | 106.4 | .    | 15.7 | 8.6  | 21.01  |
| 87921 | 128.2 | 104.5 | .    | 14.8 | 7.6  | 19.99  |
| 87922 | 177.8 | 146.3 | .    | 21.6 | 11.1 | 61.01  |
| 87923 | 162.6 | 132.6 | .    | 19.5 | 11.3 | 43.53  |
| 87924 | 168.0 | 140.3 | 12.2 | 20.0 | 11.9 | 53.41  |
| 87925 | 167.1 | 136.5 | 16.0 | 23.0 | .    | 47.62  |
| 87926 | 174.4 | 147.4 |      | 21.1 | 10.1 | 54.28  |
| 87824 | 192.2 | 152.9 | .    | 23.2 | 12.1 | 73.40  |
| 87825 | 181.4 | 148.2 | 16.2 | 23.4 | 10.4 | 66.05  |
| 88122 | 274.3 | 224.4 | 19.8 | 33.7 | 18.8 | 251.78 |
| 88123 | 250.0 | 205.9 |      | 29.9 | 10.2 | 206.62 |
| 11270 | 187.0 | 162.0 | .    | 21.9 | 12.0 | 79.95  |
| #1    | 295.0 | .     | .    | 37.1 | .    | .      |
| #2    | 270.0 | .     | 22.2 | 34.8 | 26.8 | .      |

|    | VARIABLES |     | REGRESION EQUATIONS   | CORRELATION COEFFICIENT | N  |
|----|-----------|-----|-----------------------|-------------------------|----|
|    | Y         | X   |                       |                         |    |
| 1. | TFL       | SFL | $Y = 1.19 X + 4.32$   | 0.996                   | 23 |
| 2. | TFL       | AB  | $Y = 10.58 X + 38.51$ | 0.940                   | 15 |
| 3. | TFL       | CD  | $Y = 7.48 X + 16.27$  | 0.990                   | 23 |
| 4. | TFL       | EF  | $Y = 8.15 X + 81.68$  | 0.817                   | 22 |

Evaluation. The width at the transverse processes is the most reliable variable. The first vertebra is often lost and if not included in the measurement it will produce a large error. The height is affected when the neural spine is partially broken. See Figs. 24 A and 24 B.

**Table 22. Opercle - dimensions and measurements.**

| NSM#  | TFL   | SFL   | AB   | AC   | BC   | AD   | TFW    |
|-------|-------|-------|------|------|------|------|--------|
| 87471 | 151.0 | 123.5 | 8.7  | 7.7  | 10.1 | 6.0  | 42.78  |
| 87472 | 143.9 | 116.1 | 8.5  | 7.5  | 8.8  | 5.0  | 34.52  |
| 87473 | 156.0 | 128.2 | 9.8  | 6.8  | 11.5 | 6.2  | 42.50  |
| 87474 | 145.5 | 119.0 | 9.0  | 7.8  | 10.7 | 6.1  | 38.50  |
| 87475 | 135.5 | 109.5 | 8.2  | 6.8  | 10.3 | 5.4  | 29.46  |
| 87477 | 142.0 | 115.2 | 8.4  | 7.5  | 10.2 | 5.9  | 30.94  |
| 87479 | 152.0 | 122.7 | 9.2  | 7.4  | 10.4 | 6.6  | 40.01  |
| 87480 | 155.9 | 128.8 | 9.4  | 7.8  | 11.3 | 6.2  | 44.40  |
| 87481 | 153.5 | 125.4 | 8.9  | 7.9  | 10.8 | 6.1  | 38.30  |
| 87482 | 149.8 | 122.9 | 9.1  | 7.8  | 11.4 | 5.7  | 43.71  |
| 87919 | 161.5 | 130.0 | 10.2 | 8.6  | 12.4 | 7.6  | 38.06  |
| 87920 | 132.7 | 106.4 | 7.8  | 7.1  | 10.3 | 5.6  | 21.01  |
| 87921 | 128.2 | 104.5 | 7.8  | 6.4  | 9.0  | 5.2  | 19.99  |
| 87922 | 177.8 | 146.3 | 11.4 | 9.7  | 13.8 | 7.7  | 61.01  |
| 87923 | 162.6 | 132.6 | 10.0 | 8.5  | 11.9 | 6.8  | 43.53  |
| 87924 | 168.0 | 140.3 | 10.6 | 8.9  | 12.6 | 12.1 | 53.41  |
| 87925 | 167.1 | 136.5 | 11.0 | 9.3  | 12.8 | 7.8  | 47.62  |
| 87926 | 174.4 | 147.4 | 10.9 | 9.1  | 12.4 | 7.5  | 54.28  |
| 87824 | 192.2 | 152.9 | 13   | 10.8 | 14.6 | 8.8  | 73.40  |
| 87825 | 181.4 | 148.2 | 12.7 | 10.5 | 15.0 | 8.1  | 66.05  |
| 88122 | 274.3 | 224.4 | 19.1 | 15.2 | 19.1 | 13.4 | 251.78 |
| 88123 | 250.0 | 205.9 | 15.6 | 12.5 | 19.1 | 9.8  | 206.62 |
| 11270 | 187.0 | 162.0 | .    | .    | .    | .    | .      |
| #1    | 295.0 | .     | 20.0 | 12.1 | 23.4 | .    | .      |
| #2    | 270.0 | .     | 20.0 | 13.5 | 22.8 | .    | .      |

| VARIABLES |         | REGRESION<br>EQUATIONS | CORRELATION<br>COEFFICIENT | N  |
|-----------|---------|------------------------|----------------------------|----|
| Y         | X       |                        |                            |    |
| 1.        | TFL SFL | $Y = 1.19 X + 4.32$    | 0.996                      | 23 |
| 2.        | TFL AB  | $Y = 12.45 X + 36.13$  | 0.989                      | 24 |
| 3.        | TFL AC  | $Y = 19.26 X + 1.58$   | 0.938                      | 24 |
| 4.        | TFL BC  | $Y = 11.37 X + 26.66$  | 0.977                      | 24 |
| 5.        | TFL AD  | $Y = 13.57 X + 67.69$  | 0.835                      | 22 |

Evaluation. The height (AD) is the least reliable measurement because of the difficulty in setting the caliper properly, especially for small specimens. See Fig. 28C.



**Table 23. Coracoid - dimensions and measurements.**

| NSM#  | TFL   | SFL   | AB   | BC   | N | TFW    |
|-------|-------|-------|------|------|---|--------|
| 87471 | 151.0 | 123.5 | 17.6 | 8.7  | 8 | 42.78  |
| 87472 | 143.9 | 116.1 | 16.5 | 8.6  | 8 | 34.52  |
| 87473 | 156.0 | 128.2 | 17.1 | 9.1  | 7 | 42.50  |
| 87474 | 145.5 | 119.0 | 16.4 | 9.0  | 8 | 38.50  |
| 87475 | 135.5 | 109.5 | 15.2 | 7.3  | 8 | 29.46  |
| 87477 | 142.0 | 115.2 | 15.3 | 7.6  | 6 | 30.94  |
| 87479 | 152.0 | 122.7 | 17.2 | 8.8  | 7 | 40.01  |
| 87480 | 155.9 | 128.8 | 17.5 | 9.5  | 8 | 44.40  |
| 87481 | 153.5 | 125.4 | 16.8 | 8.2  | 7 | 38.30  |
| 87482 | 149.8 | 122.9 | 17.3 | 8.7  | 7 | 43.71  |
| 87919 | 161.5 | 130.0 | 17.7 | 8.5  | 6 | 38.06  |
| 87920 | 132.7 | 106.4 | 13.7 | 6.6  | 7 | 21.01  |
| 87921 | 128.2 | 104.5 | 14.0 | 6.7  | 7 | 19.99  |
| 87922 | 177.8 | 146.3 | 20.6 | 8.6  | 6 | 61.01  |
| 87923 | 162.6 | 132.6 | 17.4 | 8.7  | 7 | 43.53  |
| 87924 | 168.0 | 140.3 | 18.2 | 9.1  | 6 | 53.41  |
| 87925 | 167.1 | 136.5 | 18.2 | 9.2  | 8 | 47.62  |
| 87926 | 174.4 | 147.4 | 20.7 | 11.3 | 7 | 54.28  |
| 87824 | 192.2 | 152.9 | 20.7 | 9.0  | 7 | 73.40  |
| 87825 | 181.4 | 148.2 | 22.3 | 10.0 | 8 | 66.05  |
| 88122 | 274.3 | 224.4 | 31.5 | 15.5 | 8 | 251.78 |
| 88123 | 250.0 | 205.9 | 25.1 | 11.9 | 8 | 206.62 |
| 11270 | 187.0 | 162.0 | 20.4 | 9.9  | 7 | 79.95  |
| #1    | 295.0 | .     | 30.2 | 15.7 | 7 | .      |
| #2    | 270.0 | .     | 30.0 | 14.4 | 7 | .      |

|    | VARIABLES                                  |     | REGRESION EQUATIONS  | CORRELATION COEFFICIENT | N  |
|----|--|-----|----------------------|-------------------------|----|
|    | Y  | X   |                      |                         |    |
| 1. | TFL  | SFL | $Y = 1.19 X + 4.32$  | 0.996                   | 23 |
| 2. | TFL  | AB  | $Y = 9.26 X - 4.23$  | 0.979                   | 25 |
| 3. | TFL  | BC  | $Y = 18.19 X + 1.25$ | 0.950                   | 25 |
| N  | Number of lobes at the coracoid symphysis. |     |                      |                         |    |

Evaluation. The coracoid is a well ossified bone. See Fig. 29D.

**Table 24. Posttemporal - dimensions and measurements.**

| NSM#  | TFL   | SFL   | AB   | CD   | TFW     |
|-------|-------|-------|------|------|---------|
| 87471 | 151.0 | 123.5 | 10.6 | 8.5  | 42.78   |
| 87472 | 143.9 | 116.1 | 10.6 | 8.0  | 34.52   |
| 87473 | 156.0 | 128.2 | 10.7 | 8.1  | 42.50   |
| 87474 | 145.5 | 119.0 | 11.0 | 8.3  | 38.50   |
| 87475 | 135.5 | 109.5 | 10.4 | 7.5  | 29.46   |
| 87477 | 142.0 | 115.2 | .    | 8.9  | 30.94 R |
| 87479 | 152.0 | 122.7 | 10.7 | 8.4  | 40.01   |
| 87480 | 155.9 | 128.8 | 11.0 | 8.7  | 44.40   |
| 87481 | 153.5 | 125.4 | 10.7 | 8.7  | 38.30 R |
| 87482 | 149.8 | 122.9 | 10.9 | 8.3  | 43.71   |
| 87919 | 161.5 | 130.0 | 12.3 | 9.6  | 38.06   |
| 87920 | 132.7 | 106.4 | 9.8  | 7.4  | 21.01   |
| 87921 | 128.2 | 104.5 | 8.9  | 7.3  | 19.99   |
| 87922 | 177.8 | 146.3 | 13.1 | 10.0 | 61.01   |
| 87923 | 162.6 | 132.6 | 11.9 | 9.3  | 43.53   |
| 87924 | 168.0 | 140.3 | 12.0 | 9.3  | 53.41   |
| 87925 | 167.1 | 136.5 | 12.1 | 9.6  | 47.62   |
| 87926 | 174.4 | 147.4 | 12.1 | 10.0 | 54.28   |
| 87824 | 192.2 | 152.9 | 14.6 | 11.3 | 73.40   |
| 87825 | 181.4 | 148.2 | 14.1 | 10.3 | 66.05   |
| 88122 | 274.3 | 224.4 | 20.6 | 16.3 | 251.78  |
| 88123 | 250.0 | 205.9 | 16.2 | 18.8 | 206.62  |
| 11270 | 187.0 | 162.0 | 13.7 | 19.4 | 79.95   |
| #1    | 295.0 | .     | 22.3 | 17.5 | .       |
| #2    | 270.0 | .     | 21.0 | 15.7 | .       |

|    | VARIABLES |     | REGRESION EQUATIONS | CORRELATION | N  |
|----|-----------|-----|---------------------|-------------|----|
|    | Y         | X   |                     | COEFFICIENT |    |
|    |           |     |                     | r           |    |
| 1. | TFL       | SFL | Y = 1.19 X + 4.32   | 0.996       | 23 |
| 2. | TFL       | AB  | Y = 12.68 X + 13.28 | 0.983       | 24 |
| 3. | TFL       | CD  | Y = 10.73 X + 62.42 | 0.863       | 25 |

Evaluation. The lower value of the width (CD) is due to the difficulty of applying properly the calipers when taking this measurement. See Fig. 30D.

**Table 25. Cleithrum - dimensions and measurements.**

| NSM#  | TFL   | SFL   | AB   | AC   | AD   | BC   | TFW     |
|-------|-------|-------|------|------|------|------|---------|
| 87471 | 151.0 | 123.5 | 25.1 | 27.4 | 19.0 | 9.0  | 42.78   |
| 87472 | 143.9 | 116.1 | 23.9 | 25.3 | 18.0 | 8.7  | 34.52   |
| 87473 | 156.0 | 128.2 | 23.3 | 25.1 | 17.7 | 9.1  | 42.50   |
| 87474 | 145.5 | 119.0 | 24.9 | 26.9 | 18.7 | 8.8  | 38.50   |
| 87475 | 135.5 | 109.5 | 22.6 | 24.7 | 16.5 | 8.6  | 29.46 R |
| 87477 | 142.0 | 115.2 | 23.4 | 25.5 | 17.3 | 8.1  | 30.94   |
| 87479 | 152.0 | 122.7 | 25.7 | 27.7 | 18.6 | 9.1  | 40.01   |
| 87480 | 155.9 | 128.8 | 25.5 | 27.9 | 19.7 | 9.2  | 44.40   |
| 87481 | 153.5 | 125.4 | 25.9 | 27.5 | 18.5 | 9.4  | 38.30   |
| 87482 | 149.8 | 122.9 | 24.2 | 27.2 | 18.9 | 9.1  | 43.71   |
| 87919 | 161.5 | 130.0 | 27.2 | 29.3 | 20.1 | 10.1 | 38.06   |
| 87920 | 132.7 | 106.4 | 21.8 | 24.5 | 16.4 | 8.3  | 21.01   |
| 87921 | 128.2 | 104.5 | 21.0 | 22.6 | 15.7 | 8.0  | 19.99   |
| 87922 | 177.8 | 146.3 | 29.1 | 30.8 | 21.4 | 10.4 | 61.01   |
| 87923 | 162.6 | 132.6 | 26.4 | 29.1 | 19.6 | 10.2 | 43.53   |
| 87924 | 168.0 | 140.3 | 28.3 | 30.7 | 20.3 | 10.8 | 53.41   |
| 87925 | 167.1 | 136.5 | 27.7 | 30.3 | 20.5 | 11.0 | 47.62   |
| 87926 | 174.4 | 147.4 | 28.5 | 31.1 | 21.1 | 11.1 | 54.28   |
| 87824 | 192.2 | 152.9 | 31.5 | 34.0 | 23.1 | 11.8 | 73.40   |
| 87825 | 181.4 | 148.2 | 33.8 | 35.4 | 25.0 | 12.5 | 66.05   |
| 88122 | 274.3 | 224.4 | 44.7 | 49.2 | 33.6 | 17.5 | 251.78  |
| 88123 | 250.0 | 205.9 | 39.2 | 42.4 | 28.1 | 15.0 | 206.62  |
| 11270 | 187.0 | 162.0 | 30.0 | 33.4 | 21.7 | 11.2 | 79.95   |
| #1    | 295.0 | .     | 51.4 | 53.3 | 36.1 | 17.8 | .       |
| #2    | 270.0 | .     | 48.1 | 51.7 | 34.2 | 17.3 | .       |

|    | VARIABLES |     | REGRESION EQUATIONS | CORRELATION COEFFICIENT | N  |
|----|-----------|-----|---------------------|-------------------------|----|
|    | Y         | X   |                     |                         |    |
| 1. | TFL       | SFL | Y = 1.19 X + 4.32   | 0.996                   | 23 |
| 2. | TFL       | AB  | Y = 5.59 X + 12.25  | 0.986                   | 25 |
| 3. | TFL       | AC  | Y = 5.36 X + 6.16   | 0.989                   | 25 |
| 4. | TFL       | AD  | Y = 8.10 X + 1.29   | 0.986                   | 25 |
| 5. | TFL       | BC  | Y = 15.43 X + 8.40  | 0.988                   | 25 |

Evaluation. Probably the best ossified bone with all points of reference well defined.  
See Fig. 31D

**Table 26. Left pectoral spine - dimensions and measurements.**

| NSM#  | TFL   | SFL   | AB   | BC  | DE  | HL/SpL | TFW    |
|-------|-------|-------|------|-----|-----|--------|--------|
| 87471 | 151.0 | 123.5 | 18.8 | 4.6 | 3.1 | 0.24   | 42.78  |
| 87472 | 143.9 | 116.1 | 18.0 | 4.1 | 3.8 | 0.22   | 34.52  |
| 87473 | 156.0 | 128.2 | 20.4 | 4.3 | 3.0 | 0.21   | 42.50  |
| 87474 | 145.5 | 119.0 | 19.0 | 4.2 | 4.1 | 0.22   | 38.50  |
| 87475 | 135.5 | 109.5 | 18.7 | 3.6 | 3.1 | 0.19   | 29.46  |
| 87477 | 142.0 | 115.2 | 19.1 | 4.1 | 2.1 | 0.21   | 30.94  |
| 87479 | 152.0 | 122.7 | 19.1 | 4.3 | 2.3 | 0.23   | 40.01  |
| 87480 | 155.9 | 128.8 | 18.9 | 4.3 | 2.1 | 0.23   | 44.40  |
| 87481 | 153.5 | 125.4 | 20.0 | 4.1 | 3.3 | 0.21   | 38.30  |
| 87482 | 149.8 | 122.9 | 19.2 | 4.4 | 3.2 | 0.23   | 43.71  |
| 87919 | 161.5 | 130.0 | 19.7 | 4.5 | 4.3 | 0.23   | 38.06  |
| 87920 | 132.7 | 106.4 | 16.8 | 4.1 | 3.5 | 0.24   | 21.01  |
| 87921 | 128.2 | 104.5 | 16.9 | 3.8 | 2.6 | 0.22   | 19.99  |
| 87922 | 177.8 | 146.3 | 20.1 | 4.8 | 3.7 | 0.24   | 61.01  |
| 87923 | 162.6 | 132.6 | 21.1 | 4.1 | 3.8 | 0.19   | 43.53  |
| 87924 | 168.0 | 140.3 | 19.4 | 5.0 | 2.5 | 0.26   | 53.41  |
| 87925 | 167.1 | 136.5 | 20.0 | 4.7 | 3.8 | 0.24   | 47.62  |
| 87926 | 174.4 | 147.4 | 19.7 | 4.8 | 3.9 | 0.24   | 54.28  |
| 87824 | 192.2 | 152.9 | 23.7 | 5.5 | 3.2 | 0.23   | 73.40  |
| 87825 | 181.4 | 148.2 | 20.1 | 5.2 | 3.2 | 0.26   | 66.05  |
| 88122 | 274.3 | 224.4 | 32.3 | 7.6 | 4.4 | 0.24   | 251.78 |
| 88123 | 250.0 | 205.9 | 26.5 | 6.8 | 3.9 | 0.26   | 206.62 |
| 11270 | 187.0 | 162.0 | .    | .   | .   | .      | 79.95  |
| #1    | 295.0 | .     | 24.1 | 7.0 | 5.7 | 0.29   | .      |
| #2    | 270.0 | .     | .    | 6.4 | 5.0 | .      | .      |

|    | VARIABLES |     | REGRESION EQUATIONS   | CORRELATION COEFFICIENT | N  |
|----|-----------|-----|-----------------------|-------------------------|----|
|    | Y         | X   |                       |                         |    |
| 1. | TFL       | SFL | $Y = 1.19 X + 4.32$   | 0.996                   | 23 |
| 2. | TFL       | AB  | $Y = 11.27 X - 59.25$ | 0.874                   | 23 |
| 3. | TFL       | BC  | $Y = 42.66 X - 30.85$ | 0.966                   | 24 |
| 4. | TFL       | DE  | $Y = 38.24 X + 42.65$ | 0.709                   | 24 |

Evaluation. The lower correlation of the spine length is due to its curvature, sometimes pronounced. See Fig 32B.

HL/ SpL index = Head length/Spine length

**Table 27. Right pectoral spine - dimensions and measurements.**

| NSM # | TFL   | SFL   | AB   | BC  | DE  | HL/SpL | TFW    |
|-------|-------|-------|------|-----|-----|--------|--------|
| 87471 | 151.0 | 123.5 | 20.6 | 4.6 | 3.5 | 0.22   | 42.78  |
| 87472 | 143.9 | 116.1 | 21.3 | 4.1 | 3.7 | 0.19   | 34.52  |
| 87473 | 156.0 | 128.2 | 18.5 | 4.5 | 3.5 | 0.24   | 42.50  |
| 87474 | 145.5 | 119.0 | 19.8 | 4.4 | 3.4 | 0.22   | 38.50  |
| 87475 | 135.5 | 109.5 | 19.1 | 4.0 | 2.3 | 0.21   | 29.46  |
| 87477 | 142.0 | 115.2 | 17.4 | 4.2 | 2.4 | 0.24   | 30.94  |
| 87479 | 152.0 | 122.7 | 19.8 | 4.4 | 2.8 | 0.22   | 40.01  |
| 87480 | 155.9 | 128.8 | 19.4 | 3.8 | 2.5 | 0.20   | 44.40  |
| 87481 | 153.5 | 125.4 | 19.8 | 4.0 | 2.5 | 0.20   | 38.30  |
| 87482 | 149.8 | 122.9 | 14.6 | 3.6 | 2.6 | 0.25   | 43.71  |
| 97919 | 161.5 | 130.0 | .    | 3.8 | 3.7 | 0.23   | 38.06  |
| 87920 | 132.7 | 106.4 | 17.1 | 4.0 | 2.9 | 0.22   | 21.01  |
| 87921 | 128.2 | 104.5 | 16.0 | 4.8 | 2.1 | 0.30   | 19.99  |
| 87922 | 177.8 | 146.3 | 22.0 | 4.7 | 4.2 | 0.22   | 61.01  |
| 87923 | 162.6 | 132.6 | 21.0 | 3.3 | 3.7 | 0.22   | 43.53  |
| 87924 | 168.0 | 140.3 | 19.4 | 4.8 | 2.6 | 0.25   | 53.41  |
| 87925 | 167.1 | 136.5 | 21.2 | 4.6 | 2.4 | 0.22   | 47.62  |
| 87926 | 174.4 | 147.4 | 19.4 | 5.2 | 3.0 | 0.27   | 54.28  |
| 87824 | 192.2 | 152.9 | 24.1 | 7.3 | 3.0 | 0.30   | 73.40  |
| 87825 | 181.4 | 148.2 | 19.7 | 4.6 | 3.1 | 0.23   | 66.05  |
| 88122 | 274.3 | 224.4 | 32.3 | 6.3 | 4.3 | 0.20   | 251.78 |
| 88123 | 250.0 | 205.9 | .    | .   | .   | .      | 206.62 |
| 11270 | 187.0 | 162.0 | .    | .   | .   | .      | 79.95  |
| #1    | 295.0 | .     | .    | 6.0 | .   | .      | .      |
| #2    | 270.0 | .     | .    | 7.1 | 4.9 | .      | .      |

| VARIABLES |         | REGRESION EQUATIONS | CORRELATION COEFFICIENTS | N  |
|-----------|---------|---------------------|--------------------------|----|
| Y         | X       |                     |                          |    |
| 1.        | TFL SFL | Y = 1.19 X + 4.32   | 0.996                    | 23 |
| 2.        | TFL AB  | Y = 7.79 X + 5.38   | 0.887                    | 20 |
| 3.        | TFL BC  | Y = 24.80 X + 49.97 | 0.683                    | 24 |
| 4.        | TFL DE  | Y = 35.41 X + 55.83 | 0.692                    | 22 |

Evaluation. Same evaluation as that given for the left pectoral spine.  
 HL/ SpL index = Head length/Spine length

**Table 28. Pelvic girdle - dimensions and measurements.**

| NSM#  | TFL   | SFL   | AB   | CD   | TFW    |
|-------|-------|-------|------|------|--------|
| 87471 | 151.0 | 123.5 | 9.8  | 4.7  | 42.78  |
| 87472 | 143.9 | 116.1 | .    | .    | 34.52  |
| 87473 | 156.0 | 128.2 | 9.6  | 5.0  | 42.50  |
| 87474 | 145.5 | 119.0 | 8.3  | 4.6  | 38.50  |
| 87475 | 135.5 | 109.5 | .    | .    | 29.46  |
| 87477 | 142.0 | 115.2 | 7.6  | 4.5  | 30.94  |
| 87479 | 152.0 | 122.7 | .    | .    | 40.01  |
| 87480 | 155.9 | 128.8 | 9.6  | 5.1  | 44.40  |
| 87481 | 153.5 | 125.4 | 10.6 | .    | 38.30  |
| 87482 | 149.8 | 122.9 | .    | .    | 43.71  |
| 87919 | 161.5 | 130.0 | 10.3 | 5.1  | 38.06  |
| 87920 | 132.7 | 106.4 | .    | .    | 21.01  |
| 87921 | 128.2 | 104.5 | .    | .    | 19.99  |
| 87922 | 177.8 | 146.3 | 11.6 | 6.4  | 61.01  |
| 87923 | 162.6 | 132.6 | 9.4  | 4.7  | 43.53  |
| 87924 | 168.0 | 140.3 | .    | .    | 53.41  |
| 87925 | 167.1 | 136.5 | .    | .    | 47.62  |
| 87926 | 174.4 | 147.4 | .    | .    | 54.28  |
| 87824 | 192.2 | 152.9 | 12.1 | 7.1  | 73.40  |
| 87825 | 181.4 | 148.2 | 13.3 | 7.2  | 66.05  |
| 88122 | 274.3 | 224.4 | 17.4 | 9.6  | 251.78 |
| 88123 | 250.0 | 205.9 | 14.6 | 8.7  | 206.62 |
| 11270 | 187.0 | 162.0 | .    | .    | 79.95  |
| #1    | 295.0 | .     | 19.6 | 10.7 | .      |
| #2    | 270.0 | .     | .    | .    | .      |

| VARIABLES |         | REGRESION<br>EQUATIONS | CORRELATION<br>COEFFICIENT | N  |
|-----------|---------|------------------------|----------------------------|----|
| Y         | X       |                        |                            |    |
| 1.        | TFL SFL | $Y = 1.19 X + 4.32$    | 0.996                      | 23 |
| 2.        | TFL AB  | $Y = 14.04 X + 21.34$  | 0.968                      | 14 |
| 3.        | TFL CD  | $Y = 23.86 X + 35.01$  | 0.978                      | 13 |

Evaluation. Although the correlations are valuable, the pelvic bones are very fragile. This is the reason for the small sample. See Fig. 33B

**Table 29. Dorsal spine - dimension and measurements.**

| NSM#  | TFL   | SFL   | AB   | TFW    |
|-------|-------|-------|------|--------|
| 87471 | 151.0 | 123.5 | 12.5 | 42.78  |
| 87472 | 143.9 | 116.1 | 15.4 | 34.52  |
| 87473 | 156.0 | 128.2 | 13.6 | 42.50  |
| 87474 | 145.5 | 119.0 | 16.1 | 38.50  |
| 87475 | 135.5 | 109.5 | .    | 29.46  |
| 87477 | 142.0 | 115.2 | .    | 30.94  |
| 87479 | 152.0 | 122.7 | 11.4 | 40.01  |
| 87480 | 155.9 | 128.8 | 16.2 | 44.40  |
| 87481 | 153.5 | 125.4 | 17.8 | 38.30  |
| 87482 | 149.8 | 122.9 | .    | 43.71  |
| 87919 | 161.5 | 130.0 | 16.6 | 38.06  |
| 87920 | 132.7 | 106.4 | 14.8 | 21.01  |
| 87921 | 128.2 | 104.5 | 14.3 | 19.99  |
| 87922 | 177.8 | 146.3 | .    | 61.01  |
| 87923 | 162.6 | 132.6 | 18.6 | 43.53  |
| 87924 | 168.0 | 140.3 | 15.8 | 53.41  |
| 87925 | 167.1 | 136.5 | .    | 47.62  |
| 87926 | 174.4 | 147.4 | 17.4 | 54.28  |
| 87824 | 192.2 | 152.9 | 18.4 | 73.40  |
| 87825 | 181.4 | 148.2 | .    | 66.05  |
| 88122 | 274.3 | 224.4 | 26.1 | 251.78 |
| 88123 | 250.0 | 205.9 | 24.3 | 206.62 |
| 11270 | 187.0 | 162.0 | .    | 79.95  |
| #1    | 295.0 | .     | .    | .      |
| #2    | 270.0 | .     | .    | .      |

Broken, but well healed.

| VARIABLES |         | REGRESION EQUATIONS | CORRELATION COEFFICIENT | N  |
|-----------|---------|---------------------|-------------------------|----|
| Y         | X       |                     |                         |    |
| 1.        | TFL SFL | Y = 1.19 X + 4.32   | 0.996                   | 23 |
| 2.        | TFL AB  | Y = 9.23 X + 13.53  | 0.893                   | 16 |

Evaluation. The value of “r” is somewhat better than those corresponding to those of the pectoral spines, probably due to the dorsal spine being straighter. See Fig. 34A.

**Table 30. Individual values of the meristic characters: gill rakers, vertebrae, and branchiostegal rays for the whole sample.**

| NSM#  | TFL   | SFL   | Gill rakers |    |       | Vertebrae |    |       | Branchiostegals |    |       |
|-------|-------|-------|-------------|----|-------|-----------|----|-------|-----------------|----|-------|
|       |       |       | CB          | EB | Total | PC        | C  | Total | CH              | EH | Total |
| 87471 | 151.0 | 123.5 | 9           | 6  | 15    | 11        | 25 | 36    | 6               | 2  | 8     |
| 87472 | 143.9 | 116.1 | 9           | 5  | 14    | 10        | 22 | 32    | 6               | 2  | 8     |
| 87473 | 156.0 | 128.2 | 8           | 5  | 13    | 7         | 24 | 31    | 6               | 2  | 8     |
| 87474 | 145.5 | 119.0 | 8           | 5  | 13    | 8         | 26 | 34    | .               | .  | .     |
| 87475 | 135.5 | 109.5 | 8           | 4  | 12    | 11        | 27 | 38    | 6               | 2  | 8     |
| 87477 | 142.0 | 115.2 | 9           | 4  | 13    | 11        | 26 | 37    | 6               | 2  | 8     |
| 87479 | 152.0 | 122.7 | 9           | 4  | 13    | 10        | 27 | 37    | 6               | 2  | 8     |
| 87480 | 155.9 | 128.8 | 9           | 4  | 13    | 11        | 24 | 35    | 6               | 2  | 8     |
| 87481 | 153.5 | 125.4 | 9           | 4  | 13    | 11        | 27 | 38    | 6               | 2  | 8     |
| 87482 | 149.8 | 122.9 | 8           | 4  | 12    | 9         | 29 | 38    | 6               | 2  | 8     |
| 87919 | 161.5 | 130.0 | 8           | 4  | 12    | 9         | 28 | 37    | .               | .  | .     |
| 87920 | 132.7 | 106.4 | 8           | 4  | 12    | 10        | 24 | 34    | .               | .  | .     |
| 87921 | 128.2 | 104.5 | 9           | 3  | 12    | 9         | 23 | 32    | 6               | 2  | 8     |
| 87922 | 177.8 | 146.3 | .           | 4  | .     | 9         | 28 | 37    | .               | .  | .     |
| 87923 | 162.6 | 132.6 | 8           | 4  | 12    | 9         | 28 | 37    | .               | .  | .     |
| 87924 | 168.0 | 140.3 | 9           | 4  | 13    | 10        | 28 | 38    | 6               | 2  | 8     |
| 87925 | 167.1 | 136.5 | 6           | 4  | 10    | 9         | 28 | 37    | 6               | 2  | 8     |
| 87926 | 174.4 | 147.4 | 8           | 4  | 12    | 10        | 27 | 37    | 6               | 2  | 8     |
| 87927 | 130.9 | 107.4 | 9           | 4  | 13    | 10        | 27 | 37    | 7               | 2  | 9     |
| 87824 | 192.2 | 152.9 | 7           | .  | .     | 9         | 28 | 37    | 6               | 2  | 8     |
| 87825 | 181.4 | 148.2 | 8           | 3  | 11    | 10        | 28 | 38    | 6               | 2  | 8     |
| 88122 | 274.3 | 224.4 | 8           | .  | .     | 9         | 27 | 36    | .               | .  | .     |
| 88123 | 250.0 | 295.9 | 9           | 4  | 12    | 10        | 28 | 38    | .               | .  | .     |
| 11270 | 187.0 | 162.0 | .           | .  | .     | 9         | 27 | 36    | .               | .  | .     |
| #1    | 295.0 | .     | .           | .  | .     | 10        | 24 | 34    | .               | .  | .     |
| #2    | 270.0 | .     | .           | .  | .     | 11        | 25 | 36    | .               | .  | .     |
| M1    | .     | .     | .           | .  | .     | 11        | 27 | 38    | 6               | 2  | 8     |

CB = ceratobranchial EB = epibranchial PC = precaudal vertebrae C = caudal vertebrae  
 CH = ceratohyal EH = epihyal



Table 31. Frequency distribution of A) gill rakers, B) vertebrae, and C) branchiostegal rays.

A. Gill rakers. Counted on the first left branchial arch. No rudiments were counted, only those rays detected by sight and needle.

|                        |    |    |    |    |    |    |   |    |
|------------------------|----|----|----|----|----|----|---|----|
| Ceratobranchial rakers | 6  | 7  | 8  | 9  |    |    |   |    |
| frequency              | 1  | 1  | 9  | 10 | =  | 21 |   |    |
| Epibranchial rakers    | 3  | 4  | 5  | 6  |    |    |   |    |
| frequency              | 1  | 15 | 3  | 1  | =  | 20 |   |    |
| Total number of rays   | 10 | 11 | 12 | 13 | 14 | 15 |   |    |
| frequency              | 1  | 0  | 8  | 8  | 1  | 1  | = | 19 |

=====

B. Vertebrae

|                     |                    |    |    |    |    |    |    |    |      |
|---------------------|--------------------|----|----|----|----|----|----|----|------|
| Weberian vertebrae  | 5 in all specimens |    |    |    |    |    |    |    |      |
| Precaudal vertebrae | 7                  | 8  | 9  | 10 | 11 |    |    |    |      |
| frequency           | 1                  | 1  | 10 | 9  | 7  | =  | 28 |    |      |
| Caudal vertebrae    | 22                 | 23 | 24 | 25 | 26 | 27 | 28 | 29 |      |
| frequency           | 1                  | 1  | 4  | 2  | 2  | 8  | 9  | 1  | = 28 |
| Total number        | 31                 | 32 | 33 | 34 | 35 | 36 | 37 | 38 |      |
|                     | 1                  | 2  | 0  | 3  | 1  | 4  | 10 | 7  | = 28 |

The total does not include the 5 Weberian vertebrae, but includes the c.u.c which was counted as one vertebra.

=====

C. Branchiostegal rays

|               |                                     |
|---------------|-------------------------------------|
| On ceratohyal | 6 rays (16 spec.); 7 rays (1 spec.) |
| On epihyal    | 2 rays (17 spec.)                   |
| Total         | 8 rays (16 spec.); 9 rays (1 spec.) |